



The new standard

of the future from ACO

ACO DRAIN® Multiline Seal in



# ACO. we care for water

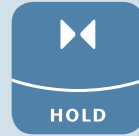

Your question – our answer:

## ACO WaterCycle

The ACO WaterCycle supports you at every stage of drainage, rainwater management and treatment planning and creates the solutions for tomorrow's environmental conditions.

Where surface water management and water protection begins

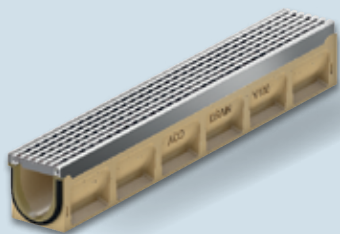

### ACO surface drainage

- Drainage channels
- Road and yard drains
- Gully tops
- Manhole covers



Achieving the right water quality



### ACO cleaning systems

- Separators
- Sedimentation and filter systems

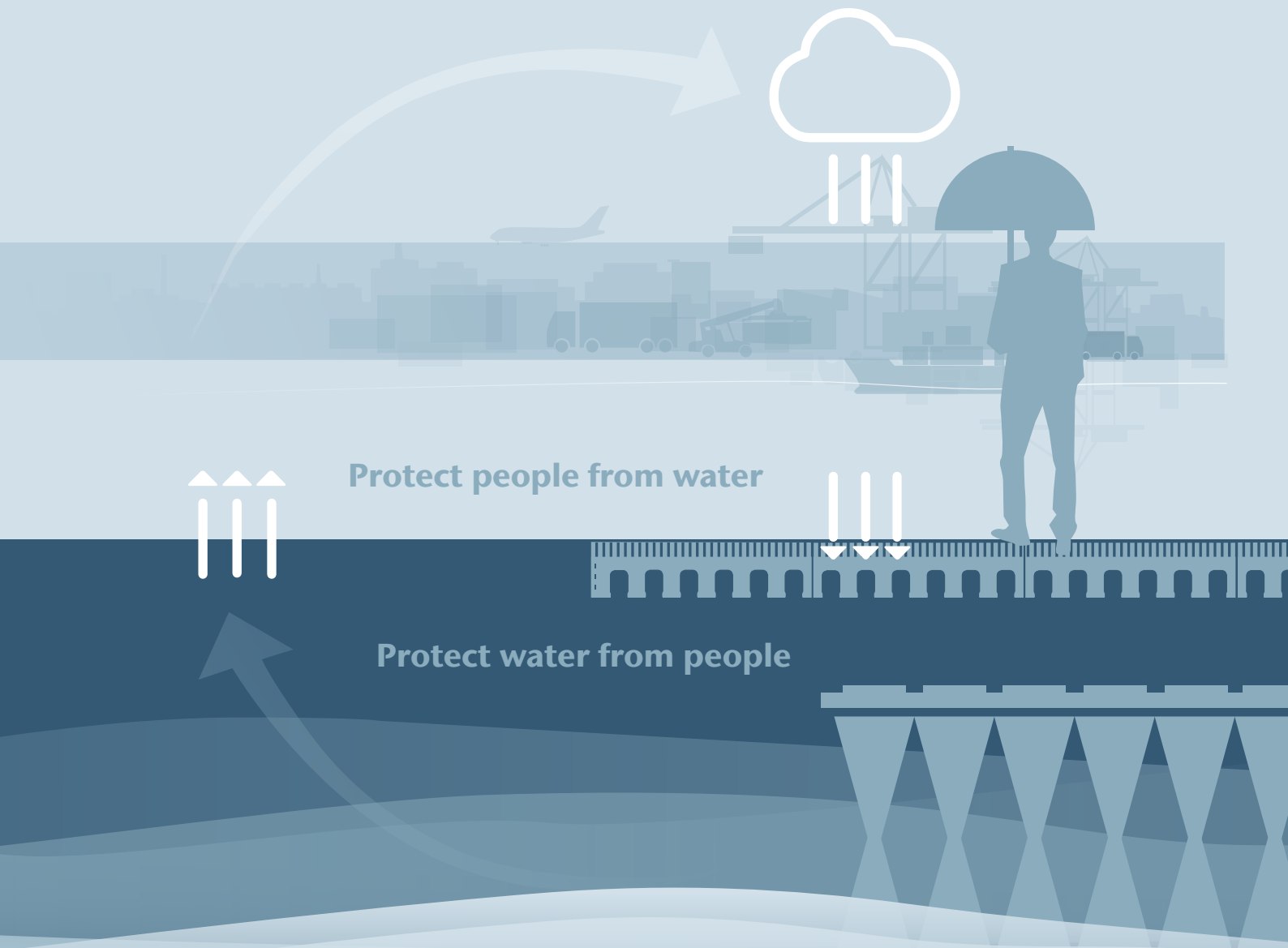

Reducing surface runoff to a natural level

Control discharge rate to the required level



**ACO retention and storage systems**

- Emergency systems
- Infiltration and attenuation systems
- Surface water retention basin



**ACO control systems**

- Flow control systems
- Pump shafts

## ACO DRAIN® range of sealed channels

Water tightness and water quality to meet the demands of tomorrow: By combining the standard integrated seal with the polymer concrete or plastic material, the sealed channels of the ACO DRAIN® product range secure the key points of a linear drainage system.

## ACO Multiline Seal in

Polymer concrete channel body with integrated seal offered with large variety of gratings made of cast iron, stainless, galvanized steel or plastic

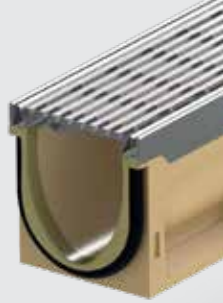

## ACO Qmax®

High-capacity slot drainage made of HD-PE with integrated seal and option for water retention or attenuation



## ACO PowerDrain

Polymer concrete channel body with integrated seal and cast iron frame for heavy duty applications



## ACO Monoblock

Monolithic polymer concrete channels for ultimate durability





Note

Any more questions?  
askACO – your local  
ACO team is proud to offer  
experience and service

[www.aco.ae/services-askaco](http://www.aco.ae/services-askaco)

**ACO. we care for water**

ACO Group	06
ACO DRAIN® - 50 years of innovation	08

1

**The Multiline Seal in product range**

Benefits for all	10
System overview	12
Features overview	13
Product advantages at a glance	14
Reliable thanks to tested watertightness	16
Versatile gratings for attractive projects	18
The choice is yours! Drainlock grating overview	20

2

**Handling of system components**

Application examples	24
Handling of components	26
Hydraulic dimensioning	28
Installation drawings	30
Quality starts with the material	32

3

**ACO Service**

Our service offer	34
-------------------	----

# ACO. we care for water

ACO is a Water-Tech company that protects water. Building on our global drainage expertise that protects people from water, we increasingly see our mission as also protecting water from people.

With the ACO WaterCycle, ACO provides systems that collect and channel, clean, retain and ultimately reuse water. In this way, ACO contributes to the preservation of clean groundwater as a vital resource, and makes a contribution to tomorrow's world. In its Agenda 2030, the UN global community set the improvement of water quality as one of 17 sustainable development goals.

Intelligent drainage systems from ACO increasingly use smart technology to ensure that rainwater and wastewater are drained, or temporarily stored. With innovative separation and filter technology, we prevent water contamination by pollutants such as fat and grease, fuels, heavy metals and microplastics.

Today, ACO goes one step further: we accept the challenge of reusing water, and thus establishing a resource-saving cycle. For all products and systems, ACO attaches great importance to durability, reusability and a low carbon footprint. The pursuit of sustainability is an ongoing process that we strive to meet every day.

The ACO Group is a global family business that is one of the world market leaders in the Water-Tech segment. Founded in Schleswig-Holstein in 1946, it operates as a transnational network in over 50 countries. Worldwide, ACO is characterised by a high level of decentralised ownership, and explicit regional market proximity.

**[www.aco.com](http://www.aco.com)**



**Holder**  
Iver and Hans-Julius Ahlmann



**Headquarters of the ACO Group**  
in Rendsburg/Büdeltsdorf



**5,200**

employees in more than 47 countries (Europe, North and South America, Asia, Australia, Africa)

**1 Billion**

Euro Sales in 2021

**37**

production sites in 18 countries



ACO Academy  
for practical training

## A Successful Market Player for over 50 years

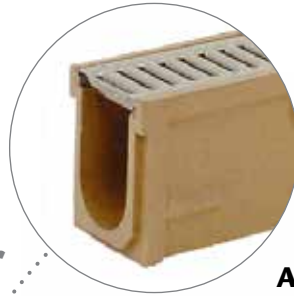

### ACO DRAIN® system N 100

In 1972, the Olympic Stadium in Munich became the first building to be drained by an ACO channel made of **polymer concrete**. Thanks to its outstanding properties, this sustainable material turned out to be truly ground-breaking: it is an ACO innovation which has endured to this very day.



### ACO DRAIN® system N 100 K

Integrated **edge protection** for a better look and **boltless locking**, which makes installation and operation so much easier.



### ACO DRAIN® Multiline

**V-shaped cross** section and a comprehensive, aesthetically-pleasing **range of gratings**: another milestone in the story of ACO DRAIN® line drainage development. ACO Multiline has already proved its worth in millions all over the world.

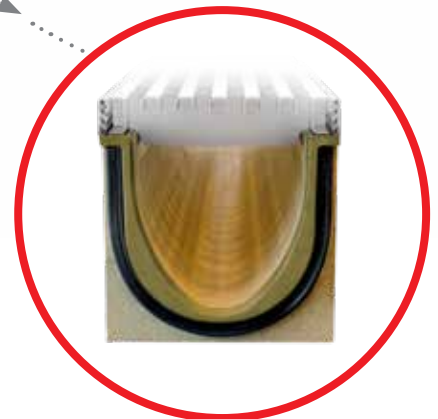



# ACO DRAIN. The Channel.

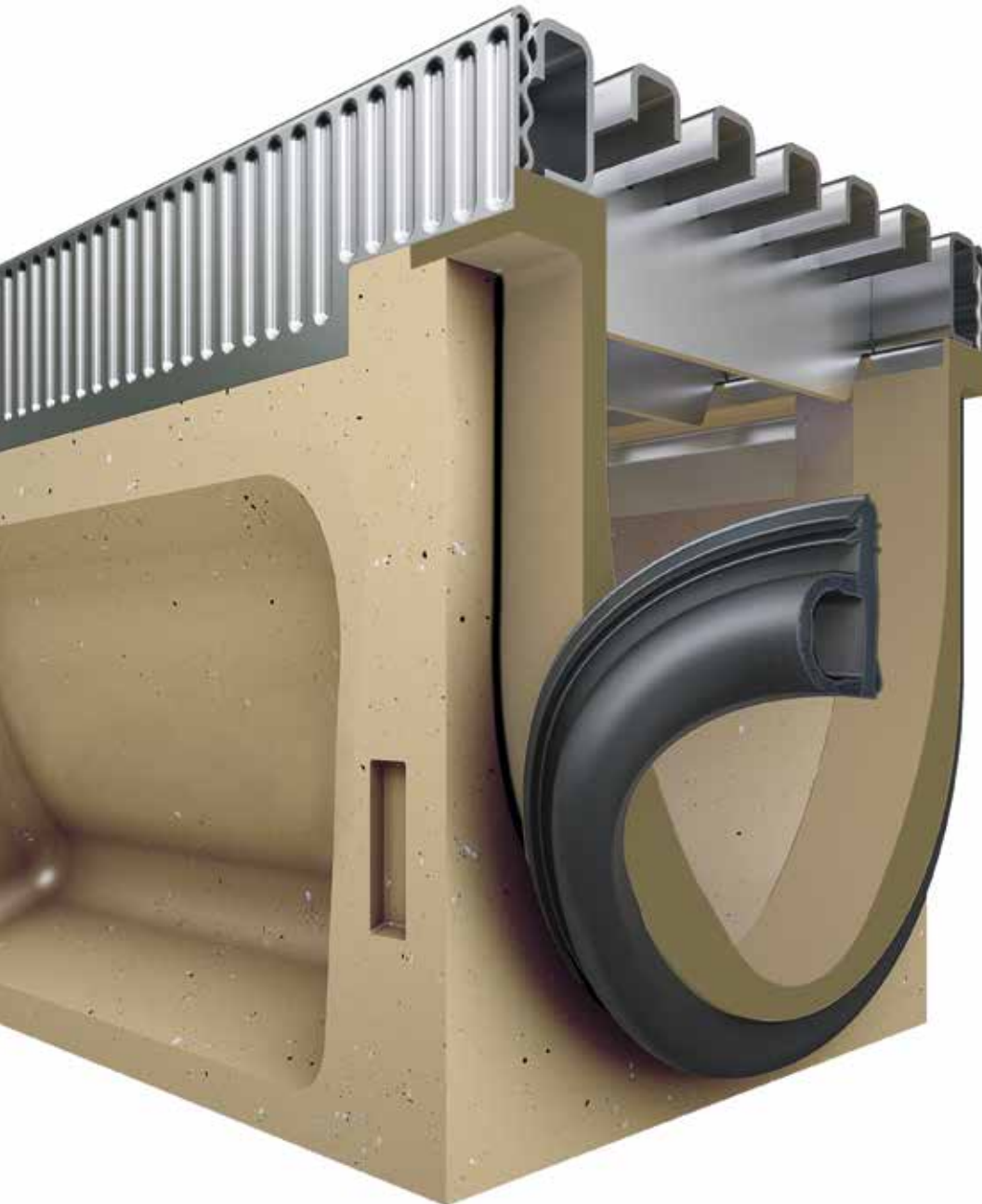

Seal in  
TECHNOLOGY

## ACO DRAIN® Multiline Seal in

ACO has always been a pioneer and has always set new standards. Now once again, the company has come up with a real sensation in the channel sector:

this channel, which comes with integrated Seal in technology included, load classes A–E and slope 1–10, brings together the very best features from 50 years of innovation – sealing as standard, easy to install as

ever and with excellent performance.

The unique combination of the ACO polymer concrete material on the one hand and sealing on the other creates the very first completely tight channel run that meets the demands of EN 1433. Lots of added value. The new standard of the future from ACO: ACO DRAIN® Multiline Seal in.

1

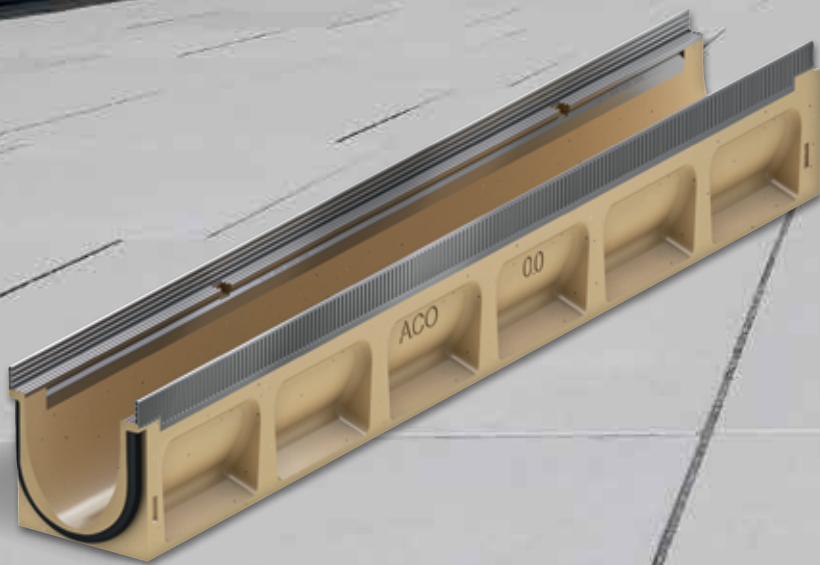

The best range of channels  
made better

ACO DRAIN® Multiline Seal in

## Benefits for all

ACO DRAIN® Multiline Seal in is based on a system concept which provides advantages for everyone: planners, dealers, contractors and building owners.

The Multiline range is recognized by professionals world-wide for its features:

- **Polymer concrete body** that features strength, weather and chemical resistance, impermeability and smooth surface, which further enhances the self-cleaning effect of the V-shape
- **Freedom of design** due to variety of widths, depths, protective edges, accessories and load classes
- **The most comprehensive range of grating designs** made of cast iron, stainless or galvanized steel or plastic

### The integrated sealing as standard

makes the range even better and ready to respond to the future demands for targeted discharge and treatment of surface water.

Any more questions?  
askACO – your local ACO team is proud  
to offer experience and service

[www.aco.ae/services-askaco](http://www.aco.ae/services-askaco)



# Multiline Seal in – drainage channel made of polymer concrete

The extensive product range of Multiline Seal in creates plenty of scope for intelligent design and construction solutions. You can choose from a variety of materials for frames and gratings, various nominal widths and add-ons. The channel system therefore enables flexible linear drainage for a wide range of applications in modern rainwater management.

### ACO product advantages

- integrated seal
- reinforced channel body
- Galvanised steel edge and stainless steel edge
- Drainlock grating

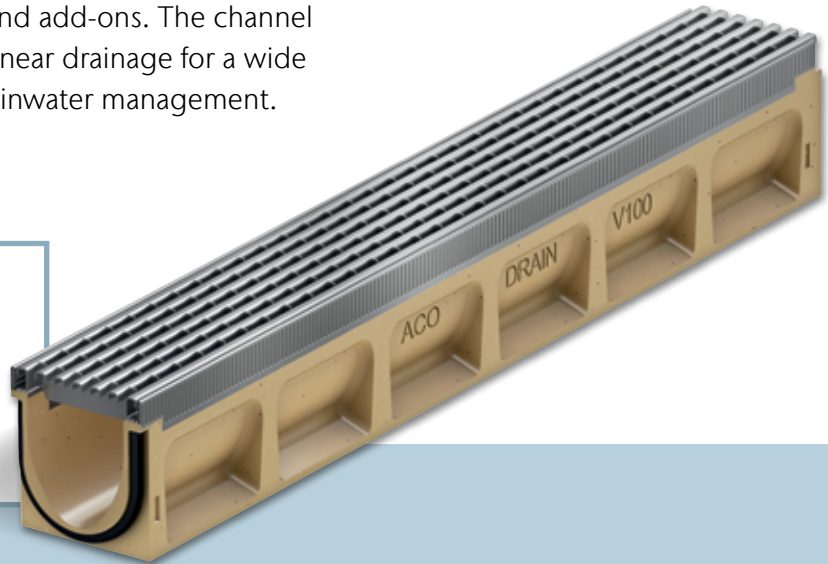

## Typical areas of use

Application	Multiline Seal in Gratings of classes A 15 - E 600
Seal type at channel joint	Seal in
Railway platforms	■
Design and light	■
Façade drainage	■
Pedestrian zones and streets	■
Landscaping	■
Public paths and spaces	■
Car parking spaces	■

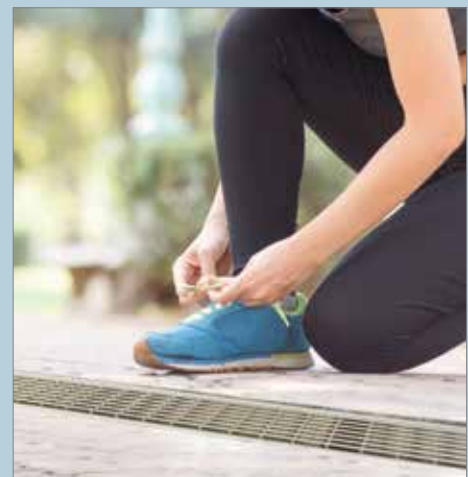

Please use our technical service to support your planning  
[www.aco.ae/aco-contacts-middle-east](http://www.aco.ae/aco-contacts-middle-east)

## Multiline Seal in system overview

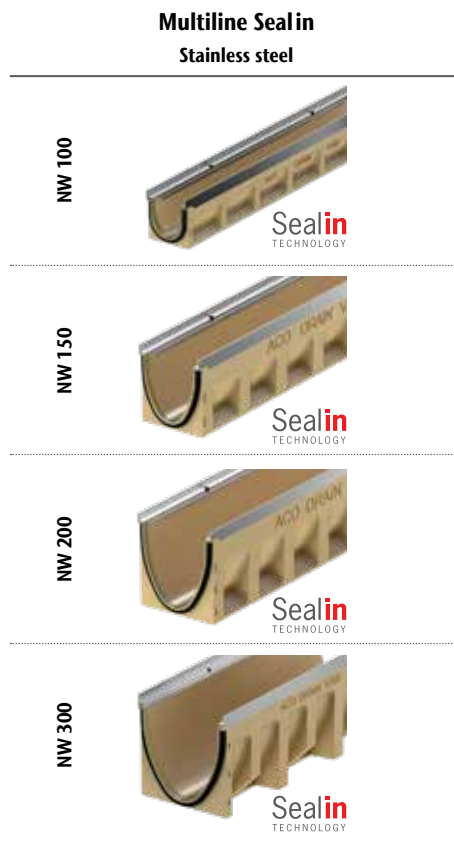
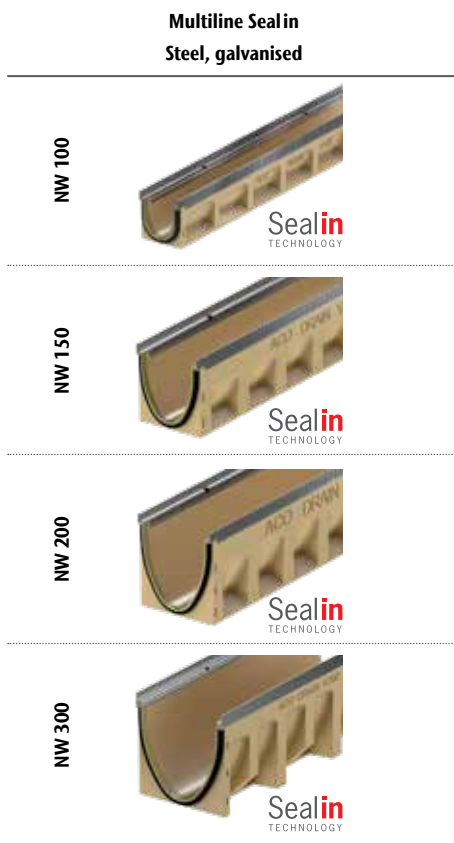

### Additions to the product range

- Channel body with liquid-tight pipe connection
- Half-metre channels
- Slope channels
- Inlet chambers
- Shallow channels



Shallow channel



Channel body with lip labyrinth seal connection



Short or long form sump unit

Product advantages  
at a glance



Seal in  
TECHNOLOGY



Video animation

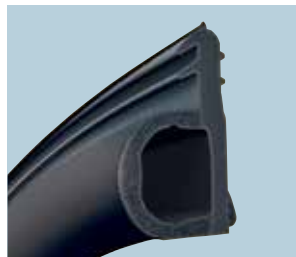

The **EPDM seal integrated as standard** connects two channel bodies to form a watertight connection.



Thanks to **ACO polymer concrete**, a material with a water penetration depth of 0 mm, the entire channel run is watertight.



**Robust channel body**

The improved geometry makes the channel body more robust. This is reflected in the optimised, application-specific installation recommendations. The concrete quality for the foundation concrete has now been reduced to C 12/15 throughout for load classes A15 to C250.

## Watertight\* channel run

### Channel joint with seal and dense material

ACO Multiline is the channel equipped with a seal as standard. Using Seal in technology, ACO securely seals the key points of linear drainage systems. This means that ACO Multiline already meets future requirements in terms of watertightness and water quality.

The unique combination of the ACO polymer concrete material and the seal ensures that for the first time, the channel run is completely watertight in accordance with the requirements of EN 1433: 2002

**\*Watertightness is certified**  
and proven by the IKT, Institute for Underground Infrastructure, Gelsenkirchen, see page 17.

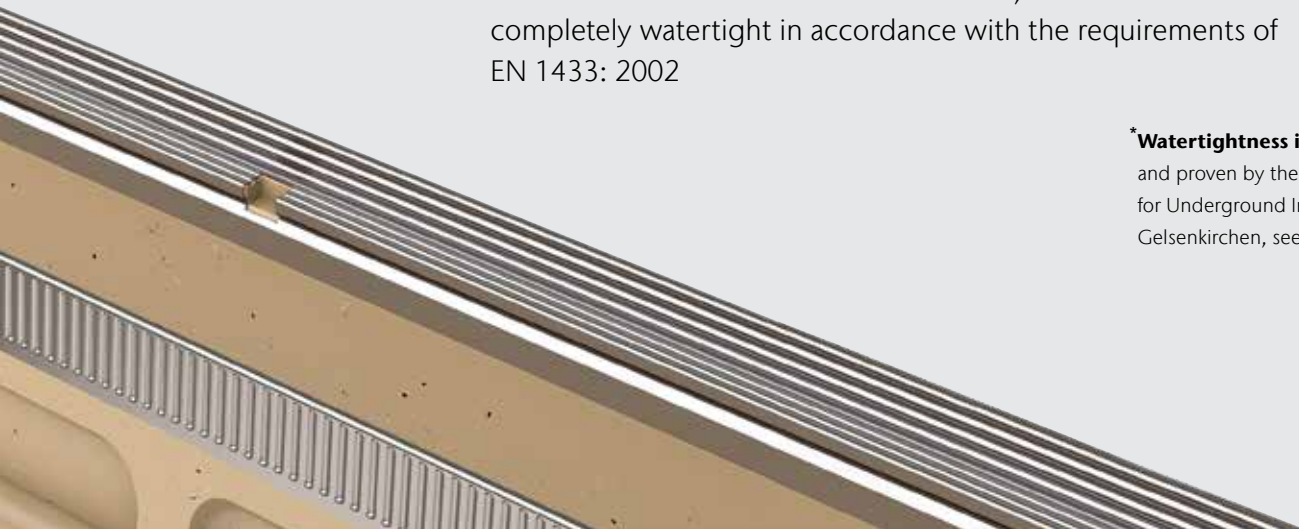

#### Improved self cleaning

Due to the even transition elements at the channel joint and the smooth surface of the ACO polymer concrete, the self-cleaning capability of the channel now works even better.



#### Proven, easy handling

ACO polymer concrete products are lighter than concrete products with the same load-bearing capacity: providing a significant advantage during handling, transport and installation.

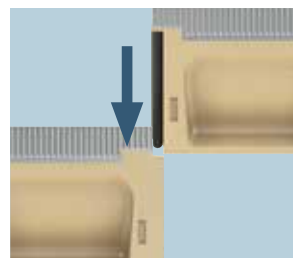

#### Easily installed from above

The simple plug-in system stays the same - nothing about the tried-and-tested installation has changed.

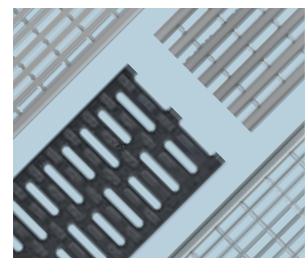

#### Grate variety for your ideas

In combination with the different ACO Drainlock gratings, landscaping can be given a unique character.

# Reliable thanks to tested watertightness

## Surface water management expert!

That is the motto of Michael Müller, Surface water management expert for ACO DRAIN® drainage channels. Right from the product development stage, the aim was to prevent irreversible damage to *nature, the environment and buildings*.

Surface runoff contains more contaminants than one might assume. Roads with heavy traffic are heavily polluted. These contaminants are washed into structures and *groundwater* when it rains and can cause a great amount of damage. Road salt, for example, can cause corrosion and weaken foundations.

ACO DRAIN® drainage channels equipped with a seal as standard collect the water and channel it away without leakage to the *rainwater treatment system* and ultimately to the natural *rainwater cycle*. They therefore make a decisive contribution to the safe collection and drainage of polluted surface water. Damage to structures, weakening of concrete foundations and the contamination of groundwater can therefore be minimised from the very beginning.

## ACO makes the channel run watertight\*

**This is made possible by the channel joint with seal and the dense material:** the unique combination of the integrated EPDM seal and the watertight ACO polymer concrete ensures a continuously liquid tight channel run in accordance with the requirements of DIN EN 1433 / DIN 19580. In addition to the ACO polymer concrete, the loss-proof two-component seal is an essential component of the **Sealin technology**.

The channel body is also produced in a special two-component process. This creates a liquid-tight channel run which transfers the collected surface runoff to the ACO system chain without any losses. Through targeted rainwater management, the structure and groundwater are permanently protected.

**Sealin**  
TECHNOLOGY





IKT - Institute for Underground Infrastructure, Gelsenkirchen



**\*Watertight – certified through long-term simulation**

The ACO Multiline with integrated Seal in technology as standard exceeds the requirements for watertightness according to DIN EN 1433 / DIN 19580, section 9.3.6 (duration of watertightness at least 30 min. +/-0.5 min.) many times over. During the leak test according to IKT certification procedure D01185, a permanent tightness was proven for 72 hours after cyclic loading. The load cycles used here simulate years of traffic crossing the channel joint.

# Versatile gratings for attractive projects

A wide range of covers creates creative scope for individual planning and design. All covers are equipped with the Drainlock screwless locking system.

Further design options are created by discreet designed SlotTops, the unmistakable grating designs of the Freestyle covers and the striking illumination provided by Sideline, Eyeleds or Lightspot.

## Highlights from the grating range A-E



### Design freedom with ACO DRAIN® Design

ACO Drainlock gratings can be combined with the ACO DRAIN® channel systems Multiline Seal in and PowerDrain Seal in up to class E 600 as well as XtraDrain and Decline up to C 250. This means that a wide range of covers in many shapes, colours and materials - made of cast iron or stainless steel, hot-dip galvanised steel or plastic - are available. It meets every requirement in terms of aesthetics, functionality and load capacity.

All Drainlock gratings in the overview see page 20/21

### Mesh grating Q+

Galvanised steel  
Stainless steel



### Hydraulics:

optimised inlet cross-section



**Longitudinal bar grating**

Galvanised steel  
Stainless steel

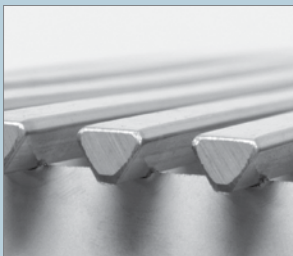

**Heelguard:**  
Slot width max. 10 mm

**Longitudinal profile grating**

Galvanised steel  
Stainless steel



**Heelguard:**  
Slot width max. 10 mm  
**Slip resistant:**  
according to DIN 51130  
at least R 11

**Designed SlotTops**

Galvanised steel  
Stainless steel



**Heelguard:**  
Slot width max. 10 mm

**Composite grating with Microgrip**

anti-slip plastic



**Heelguard:**  
Slot width max. 10 mm  
**Slip resistant:**  
according to DIN 51130  
at least R 11

## Drainlock grating

### Slotted grating

Galvanised steel  
Stainless steel



### Slotted grating

Cast iron



### Slotted grating

Heelguard:  
Cast iron



### Composite grating

black Plastic



### Composite grating

silver-grey Plastic



### Crosswise rod grating

Stainless steel



### Longitudinal bar grating

Galvanised steel  
Stainless steel



### Longitudinal bar grating

Stainless steel



### Longitudinal profile grating

Galvanised steel  
Stainless steel

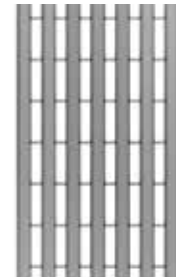

**Seal in**  
TECHNOLOGY

The choice  
is yours!

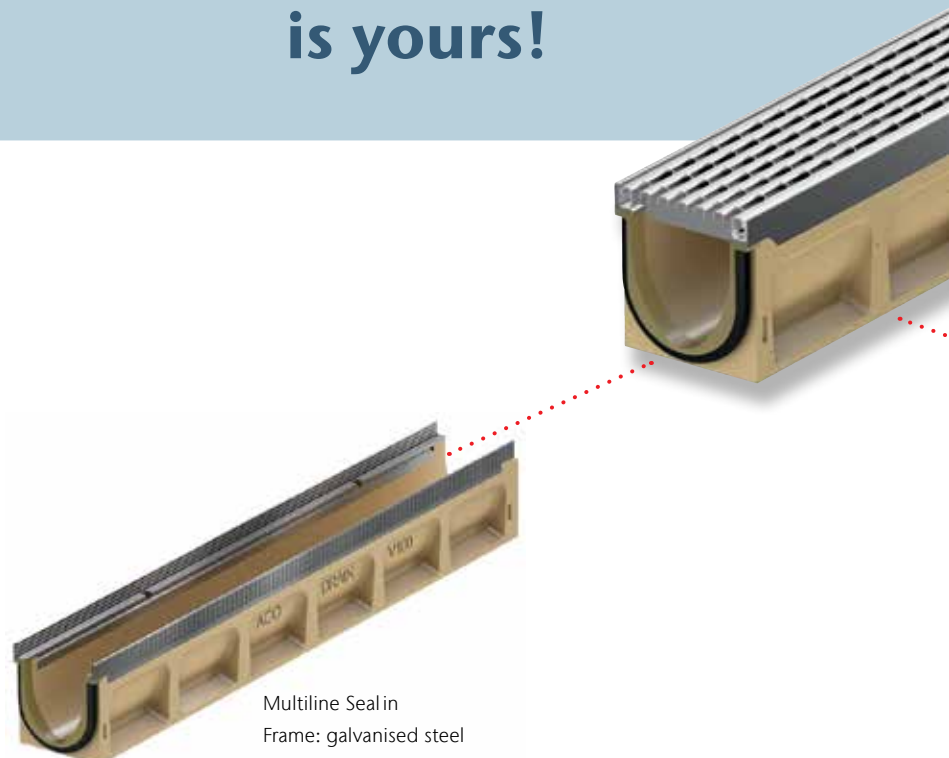

Multiline Seal in  
Frame: galvanised steel

**Longitudinal bar grating**

In mesh design  
Cast iron



**Longitudinal bar grating**

Design Ray  
Cast iron



**Mesh grating Q+**

Galvanised steel  
Stainless steel

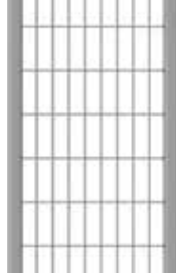

**Perforated grating**

Galvanised steel  
Stainless steel



**Slot top grating**

Galvanised steel  
Stainless steel



**Light point**

Cast iron  
LED lighting



**Sideline**

Stainless steel  
LED lighting



**Eyeleds**

Plastic  
LED lighting



**Freestyle**

Cast iron grating  
Customised design



**Solid cover**

Cast iron

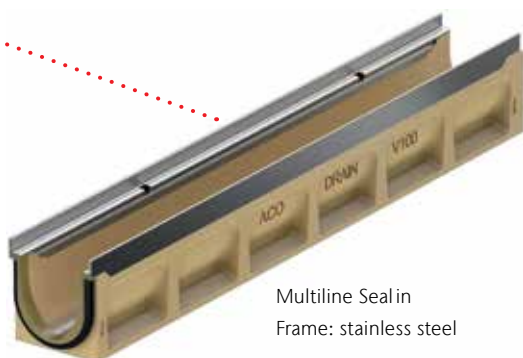
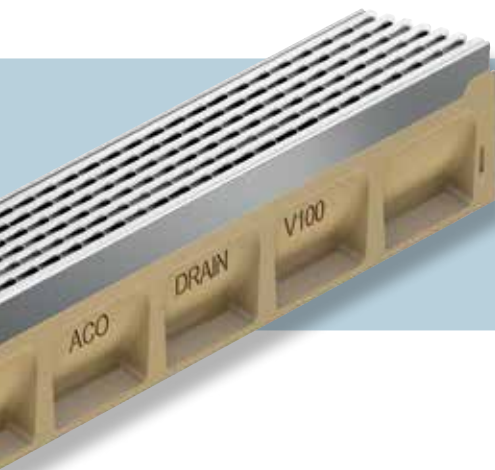
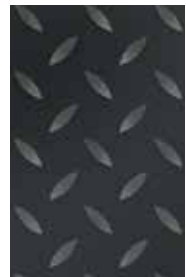

Multiline Seal in  
Frame: stainless steel



**The complete grating product range in the grating configurator**

The configurator makes it possible to select gratings and covers according to visual criteria in different scenarios. Technical information can be downloaded or saved in the object file.

[www.draindesign.aco](http://www.draindesign.aco)

2





## System elements and their handling in practice

### Multiline Seal in

Multiline Seal in system consists of thoughtfully designed components with some refinements for quick installation. Our ACO sales and consulting team is always available to answer any further questions you may have. You can find your point of contact at under:

**[www.aco.ae/aco-contacts-middle-east](http://www.aco.ae/aco-contacts-middle-east)**

# Application examples

The ACO DRAIN® Multiline System can be used in a variety of applications. The drainage system offers reliable solutions both in inner-city areas as well as out of town.





Tip



**Flughafenfeuerwehr Leipzig**  
ACO Drainierung für die Sicherheit

Top references of the ACO Group you find on:

**[www.aco.com/en/  
products-and-services/  
references-world-wide](http://www.aco.com/en/products-and-services/references-world-wide)**



# Handling of ACO Multiline components in detail



## Installing the channel

During installation apply special ACO silicone to the integrated EPDM seal to ensure a watertight connection



- ACO silicone grease for the seal

## Connecting a channel to the sump unit (NW 100)

Connection adapter is included in the delivery of the sump unit. NW 150/200 use sump units without adapters.



- Shorten the connection adapter according to the type of channel being connected.
- push all the way up
- press on and snap into place

## Installing the end cap on the sump unit (NW 100)

The end cap for the sump unit is included as part of the delivery of the sump unit. If one side of the sump unit is not connected to a channel it must be closed off with an end cap.



- push all the way up
- press on and snap into place

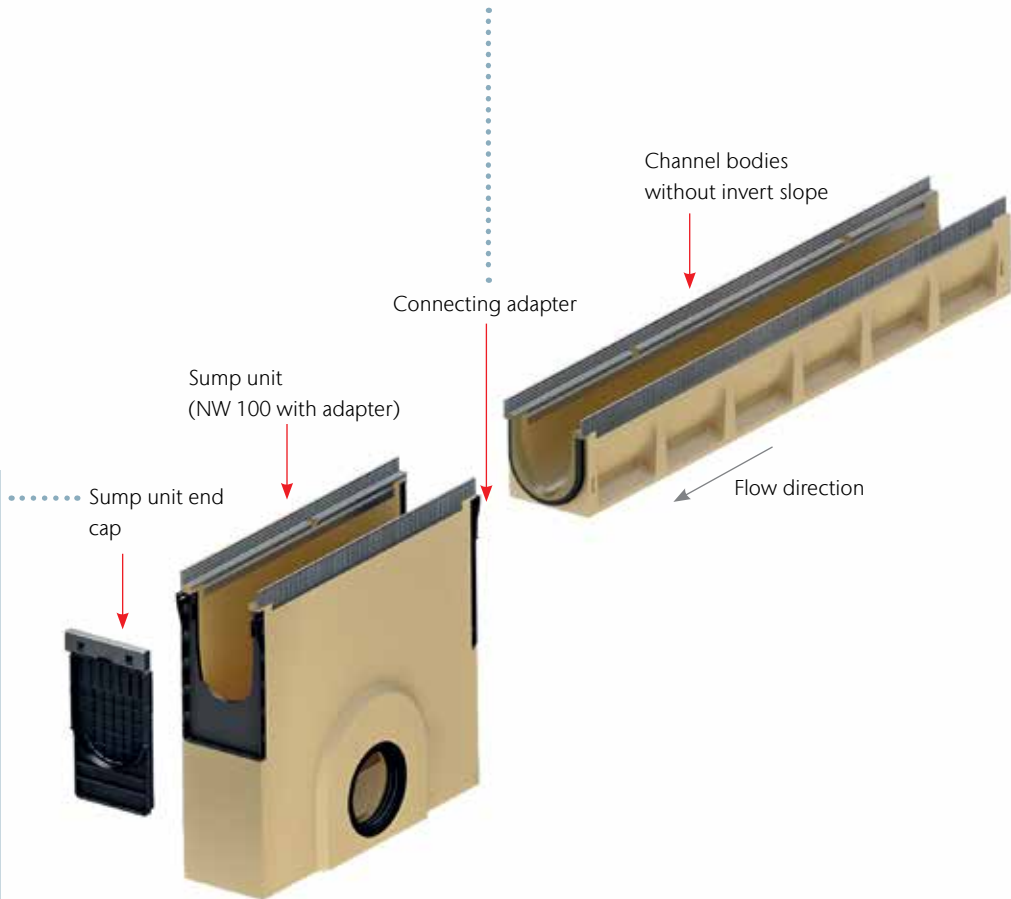

**Making fitting pieces**

For custom construction lengths, channel bodies can be cut to size with a diamond cutting disc. Polyester adhesive permanently bonds the cut pieces. The same applies to the adapter for changing the flow direction.



End cap for channel end with lip labyrinth seal (LLS) for horizontal watertight pipe connection



Adapter for change of flow direction



shortened channel body

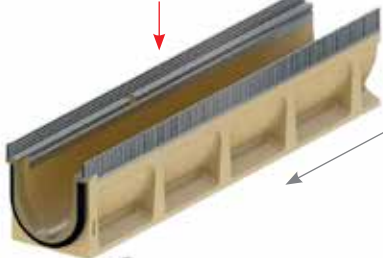

Channel body  
Half metre without base slope

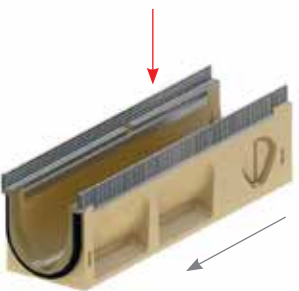

Adapter for corner, T- and cross-connections



Universal closing end cap made of plastic, from NW 150 made of polymer concrete



**How to prepare a cross section**

Pre-drill the side opening on the half-metre element and knock it out with a hammer and chisel. Then glue the channel and adapter together.



**Multifunctional closing end cap for channel start and end**

Turn the end cap by 180 degrees to ensure an exact fit on the inlet and outlet side.

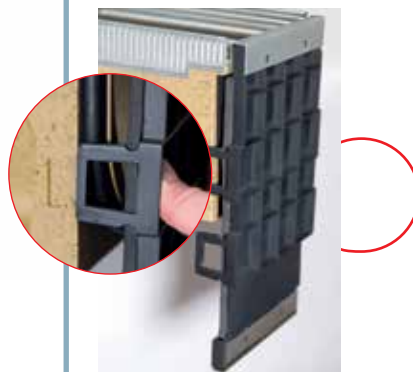

- snap into recess
- for all heights

# Hydraulic dimensioning

## Calculating the total water volume

Use the universal formula on the right to determine the rainfall runoff and calculate the water volume that accumulates on your catchment area. Use the value Q (l/s) to find the nearest value in the table and therefore the suitable channel system.

The catchment area is the area that slopes towards the channel. Specialist planners take the amount of rainfall from the KO-STRADA data of the German weather service or from DIN 1986. Roughly speaking, 300 l/(s \* ha) can be used. The runoff coefficient is to be set at 1.0 or according to DIN 1986.

$$Q = \frac{A \times r_{i(n)} \times \Psi}{10,000}$$

- A = Catchment area [m<sup>2</sup>]
- r<sub>i(n)</sub> = Quantity of rain [l/(s \* ha)]
- Ψ = Runoff coefficient [–]
- Q = Water volume [l/s]

## Choosing a channel type

Use the calculated proportional water quantity (l/s) and the hydraulic channel run (m) to determine the channel system you need from the table.

at the sump unit with a DN ≥ the channel width and are based on a **horizontal channel installation**.

In order to take pollution into account, the values are calculated using an **80 %** hydraulic capacity utilisation of the channels.

The values in the table are selected on the assumption that there is a connection pipe

Hydraulic channel run [m]	Slope type	Channel system ACO DRAIN® Multiline Seal in			
		V 100 [l/s]	V 150 [l/s]	V 200 [l/s]	V 300 [l/s]
up to 10 m	Water surface slope type 0.0	2.7	7.9	16.8	47.0
	Water surface slope type 10.0	5.2	12.4	23.8	60.0
	Base slope type 1 -10	5.0	11.5	20.0	70.0
up to 20 m	Water surface slope type 0.0	2.4	7.4	15.6	45.0
	Water surface slope type 10.0	4.8	11.6	22.0	58.0
	Base slope type 1 -10 and type 10.0	5.7	15.0	27.0	82.0
up to 30 m	Water surface slope type 0.0	2.0*	6.2*	13.0*	43.5*
	Water surface slope type 10.0	3.8	9.8	18.6	55.5
	Base slope type 1 -10 and type 10.0	6.9	14.8	25.5	81.0

\* We recommend type 10.0 for longer hydraulic channel runs

## Determining the hydraulic channel run

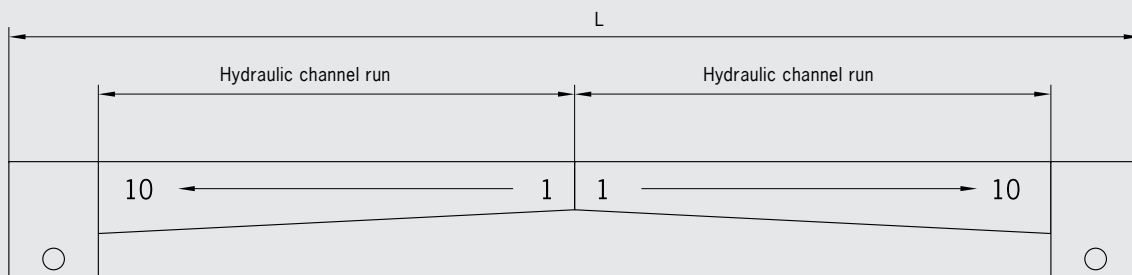
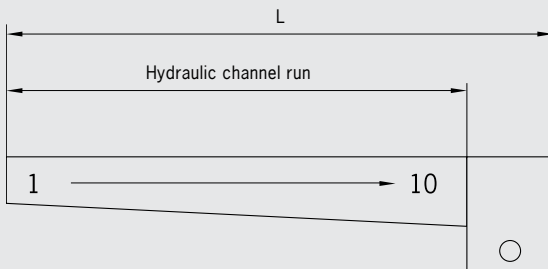
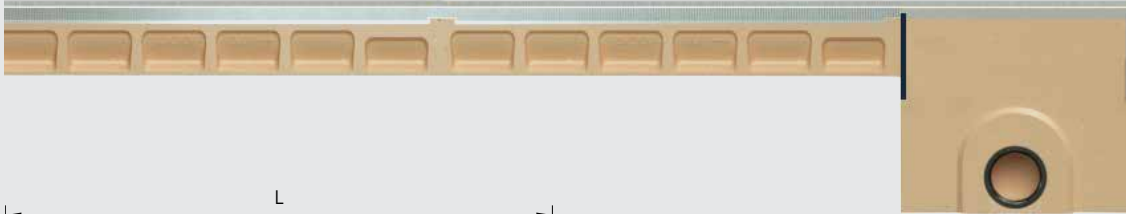

## Slope types



Water surface slope/  
slope in the terrain

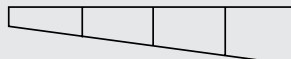

Base slope as sloped system in  
the bottom of the channel 0.5 %.

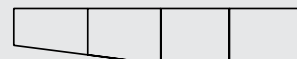

Bottom slope as sloped system in  
the bottom of the channel 0.5 %  
and water surface slope

### Additional information

- Please contact our technical service for a detailed calculation with regard to the respective sump units.
- Please note that the values are based on a sufficiently dimensioned connection line. This pre-dimensioning only includes the required nominal width of the channel system.

### Service

ACO technical service will help you find the best solution.

[www.aco.ae/aco-contacts-middle-east](http://www.aco.ae/aco-contacts-middle-east)

# Channel body installation with steel and stainless steel edges

Examples from the installation instructions

## Installation in asphalt – Class A 15 to D 400

for extreme loads see index list \*7 and installation E 600

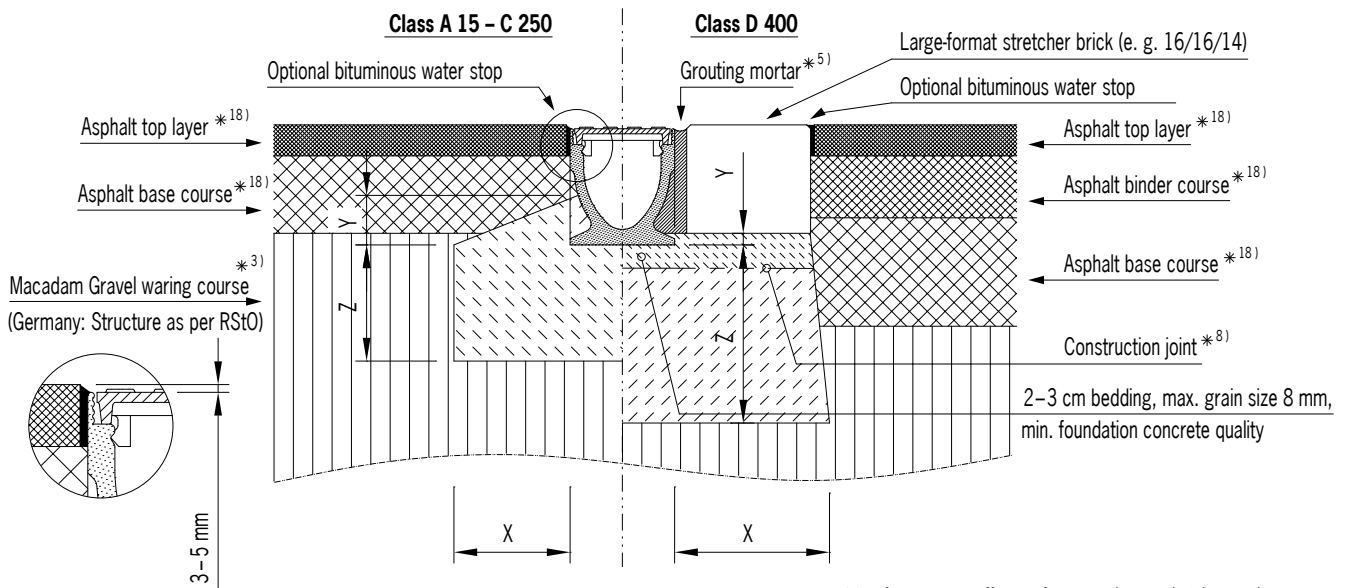

Not for cross-traffic on frequently used side roads, in residential areas, on motorways and dual carriageways and at level crossings.

Class		A 15	B 125	C 250	D 400	E 600
<b>Compressive strength class for foundation concrete</b>	(according to BS EN 1433)	≥ C 12/15	≥ C 12/15	≥ C 12/15	≥ C 25/30	object-specific
<b>Exposure class of foundation concrete *<sup>16)</sup></b>	(according to BS EN 206 -1)	(X0)	(X0)	(X0)	(X0)	on request
<b>Foundation dimensions– type M</b>	(according to BS EN 1433)	<b>x [cm]</b>	≥ 10	≥ 10	≥ 15	≥ 20
		<b>y [cm]</b>	Half height channel element		Lower edge of the stretcher brick	
		<b>z [cm]</b>	≥ 10	≥ 10	≥ 15	≥ 20

Applies only in combination with the general preliminary remarks and the index list of our installation instructions!

Drawing G1-E01-770-3 and 773-3.1, as at May 2016  
\* from NW 300 ≥ C 20/25

## Installation in pavement – Class A 15 to D 400

for extreme loads see index list \*7

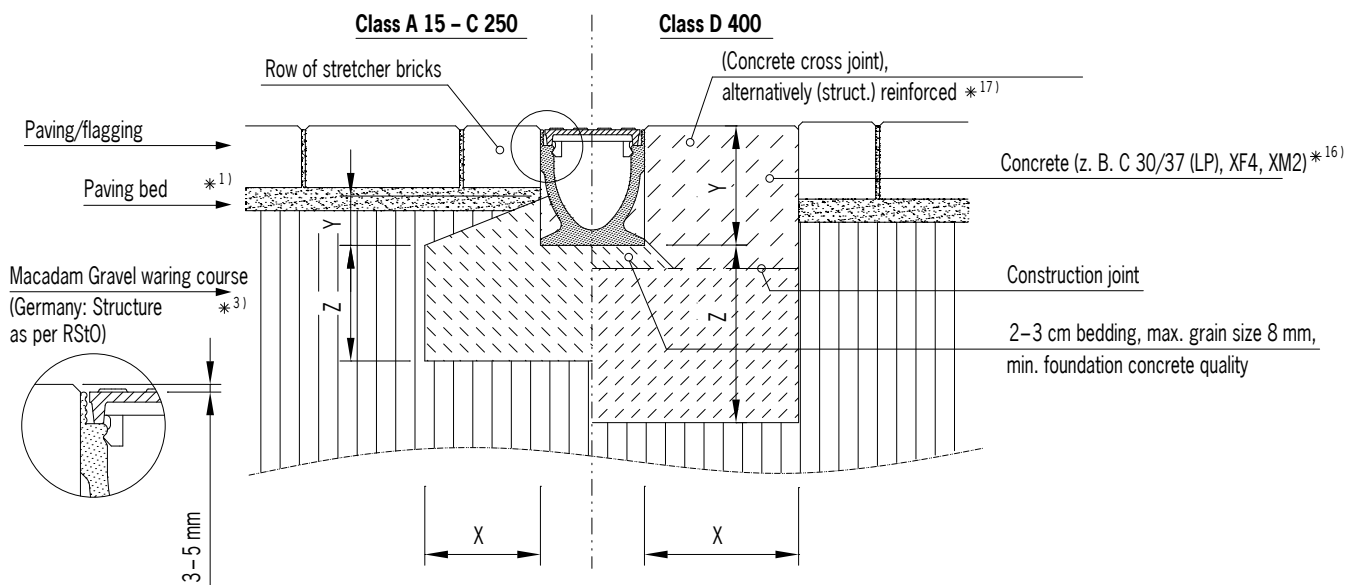

Not for cross-traffic on frequently used side roads, in residential areas and at level crossings.

Class		A 15	B 125	C 250	D 400	E 600
<b>Compressive strength class for foundation concrete</b>	(according to BS EN 1433)	≥ C 12/15	≥ C 12/15	≥ C 12/15*	≥ C 25/30	object-specific
<b>Exposure class of foundation concrete *16)</b>	(according to BS EN 206 -1)	(X0)	(X0)	(X0)	(X0)	on request
	<b>x [cm]</b>	≥ 10	≥ 10	≥ 15	≥ 20	
<b>Foundation dimensions– type M</b>	(according to BS EN 1433)	Half height channel element				Overall height of the channel element
	<b>y [cm]</b>					
	<b>z [cm]</b>	≥ 10	≥ 10	≥ 15	≥ 20	

Applies only in combination with the general preliminary remarks and the index list of our installation instructions!

Drawing G1-E01-770-3 and 773-3.1, as at May 2016  
\* from NW 300 ≥ C 20/25



### Note

Any more questions?  
askACO – your local  
ACO team is proud to offer  
experience and service

[www.aco.ae/services-askaco](http://www.aco.ae/services-askaco)

## Quality starts with the material

When designing building elements and technical details, the choice of the right material determines aesthetics and functionality. The materials used by ACO are characterised by their strength, their ageing resistance and their resistance to aggressive media, frost, heat and sunlight. Thanks to their long service life and recyclability, they are equally sustainable and environmentally friendly and are used in a manner appropriate to the application.







Polymer concrete

One step ahead

The special material composition and state-of-the-art production technologies provide ACO polymer concrete with its outstanding property profile. The ACO polymer concrete products have high strength values and a lower weight. ACO polymer concrete is impermeable to water. Water dries off quickly. Frost damage is excluded. The smooth surface area of ACO polymer concrete enables water and dirt particles to flow off quickly and is easy to clean. In addition, polymer concrete is resistant to aggressive media even without additional coatings and is also versatile and durable even under extreme conditions.



Steel/stainless steel

Sophisticated components

Both the processing of steel as well as stainless steel is a core competence of ACO in the various production facilities of the ACO Group worldwide. High investment sums ensure that our production facilities are always state of the art. The high qualification of the skilled workers ensures high product quality. Our own systems for surface protection and surface refinement are used, for example, in the production of ACO Drainlock gratings.



EPDM – for the seal

Durable and secure

A wide variety of weather conditions, such as heat exposure, can cause conventional materials and systems to age quickly. This is where synthetic ethylene propylene diene monomer rubber, or EPDM for short, shows its strength. Due to the molecular network structure, the material offers both flexibility and durability. The process for producing EPDM was justifiably awarded a Nobel Prize in 1963.



Plastic

Innovative and flexible

Construction elements and technical details made of plastic offer the greatest possible design freedom in terms of form and function. We use this potential to avoid complex material combinations and joining processes and instead develop intelligent solutions "from a single mould" or solutions with great attention to detail - such as the composite grating with microgrip. The plastics utilised by ACO are characterised by their high breaking strength as well as their excellent resistance to environmental influences.

# Our service offer

Each project is different and has its own specifications and challenges. Aside from our products, we can also offer you our know-how and services, so we can develop tailor-made solutions together – from planning to support after completion. ACO is your first point of contact in all project phases.

train:

## **Information and Further Education**

In the ACO Academy we share the know-how of the worldwide ACO Group with architects, planners, processors and traders, for whom quality is important. You are invited to share these benefits.

design:

## **Planning and Optimisation**

The specification and design of drainage solutions allows many variations. Yet which concept produces the most profitable and technically most reliable solution? We help you to find the right answer.

support:

## **Construction Consultation and Support**

To ensure that no unpleasant surprises occur between the planning and implementation of a drainage solution, we advise and assist you for a specific project on your construction site.

care:

## **Inspection and Maintenance**

ACO products are designed and produced for a long life. With our after-sales offers we ensure that ACO fulfils your high quality standards for many years.



Any questions?

askACO



Our invitation for you: askACO

Together we will find the right solution to your specific drainage requirements.  
**[www.aco.com](http://www.aco.com)**

### **ACO drainage systems for roads and highways**

As a global market leader in drainage technology, ACO has set itself the challenge of developing special products for road and highway construction and its associated infrastructure. The diverse range of climatic conditions and the respective local variations require solutions that are both ecological and economical. ACO drainage systems include not only standard products, but also solutions that

are created specifically to suit the needs of particular projects. In addition to our products, we are proud to offer our experience and service, which allow us to work with you to develop customised solutions. ACO's technical expertise is always on hand when you need it. From the initial designs to commissioning and everything in between, our engineers are here to help you.

**[www.aco.ae](http://www.aco.ae)**

Every ACO product supports  
the ACO WaterCycle



- 
- Drainage channels
  - Road and yard drains
  - Gully tops
  - Manhole covers
  - Rainwater treatment
  - Infiltration and attenuation
  - Pump shafts
  - Flow control systems
  - Tree protection
  - Amphibian protection
- 

#### ACO Systems FZE

P.O. Box 18672, Dubai  
Jebel Ali Free Zone  
Street 100, Building 07  
United Arab Emirates

[info@aco.ae](mailto:info@aco.ae)  
[www.aco.ae](http://www.aco.ae)



ACO. we care for water

