

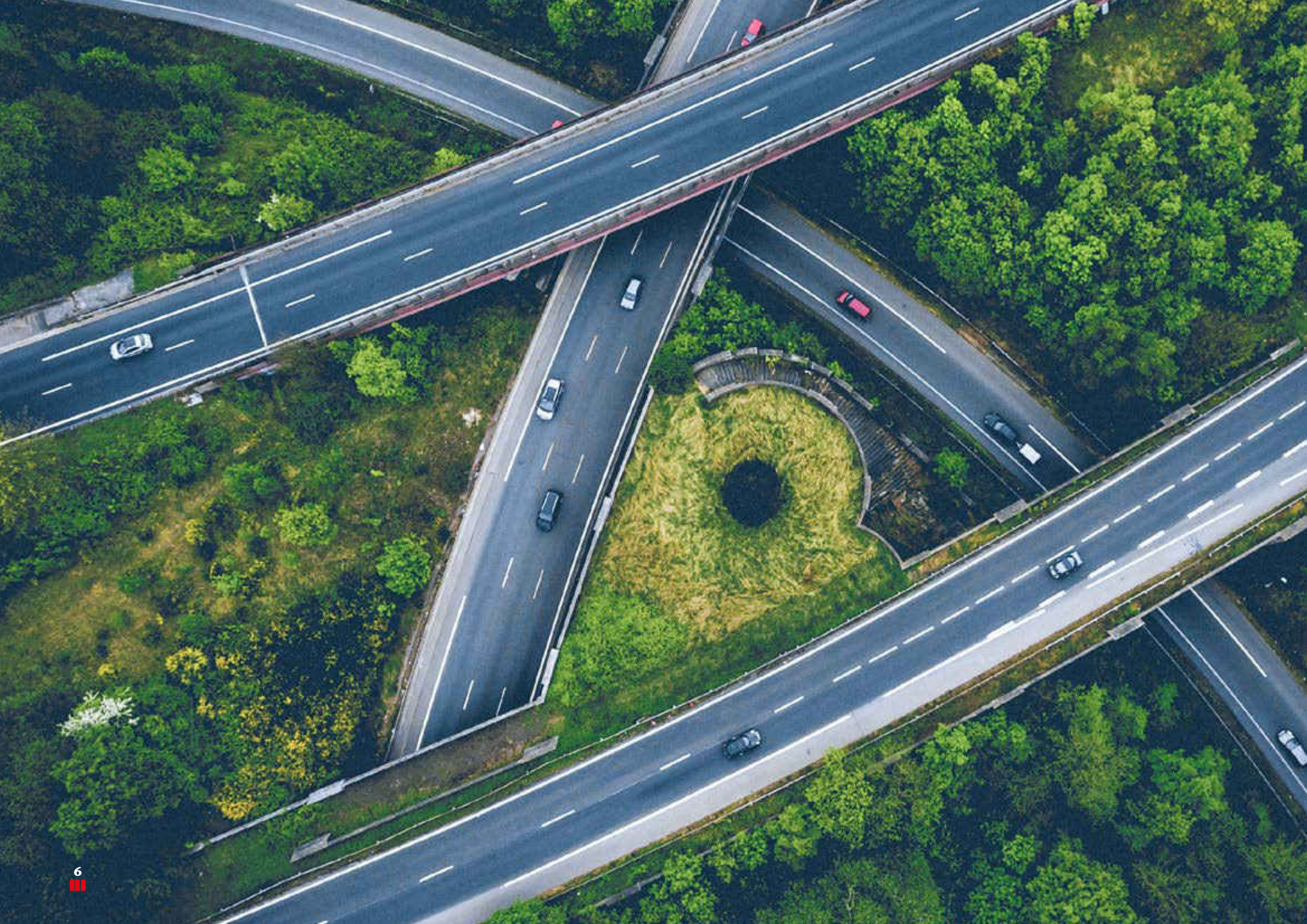

ACO Solutions for
Road infrastructure

Helping to create safe and modern highways, tunnels and bridges







ACO Group

08

How can ACO help?

Innovative solutions and expert support

10

1

Highways

ACO Monoblock RD
ACO KerbDrain
ACO Qmax
ACO Oleopator G
ACO Stormclean
ACO HMS
ACO Stormbrixx SD

Challenges, norms and solutions

14

Monolithic drainage channels 18
Combined kerb and drainage system 22
Slot drainage with high hydraulic capacity 26
Light oil separator from glass reinforced plastic 30
Technical filter 34
Heavy metal separators 38
Surface water infiltration and storage system 42

2

Tunnels

ACO ProTunnel
ACO Multitop
ACO Emergency valve system
ACO Oleopator-Bypass
ACO GRP Tank

Challenges, norms and solutions

54

Line drainage for tunnels 58
Watertight manhole covers with bolt locking 62
Valve for separating dangerous substances 66
Oil separators with integrated bypass 70
Tank for collection of dangerous substances 74

3

Bridges

ACO KerbDrain KD200
ACO BridgeDrain
ACO Pipe

Challenges, norms and solutions

84

Combined kerb and drainage system for bridges 88
Cast iron bridge gully 92
Drain pipes from stainless or galvanized steel 96

4

Roads

ACO Klimatunnel
ACO Combipoint
ACO Multitop Bituplan

Challenges, norms and solutions

106

Tunnels for protection of amphibians 110
Cast iron gullies with high hydraulic capacity 114
Self-levelling manhole covers 118

ACO. creating

the future of drainage

ACO protects water from people and vice versa.

Our motivation is to shape the future of drainage, be the innovation leader, and to do so as a business focused on the environment. Our business not only satisfies the high demands required by function and sustainability, but also for products to satisfy the needs of aesthetically pleasing architectural design. This ambition also has consequences for our organisation internally; our tools and methods across the whole of the company must reflect modern thinking. We must be at the forefront of development, and at the same time be the driving force for our commitment to excellence with passion. ACO's aim is to be the highly innovative partner for everyone involved in building the world of tomorrow:

- Increased urbanisation: Urbanisation leads to increased concentration of people in major cities, with the associated increase in density together with impervious paving of surfaces. This leads to a rapid increase in the demands placed on Surface Water Management - all around the world.
- Climate change: Increasing climate change is giving rise to more frequent heavy-rainfall events, which in turn leads to greater flooding
- Environmental pollution: Increasing environmental pollution gives rise to greater contamination of surface water, and thus pollution of the groundwater. Drinking water reserves in some parts of the world are now at risk. This has given rise to a considerable increase in awareness of the problem as laws have been tightened.





5.400

employees in more than 44 countries around the world (Europe, North and South America, Asia, Australia, Africa)

35

production facilities in 18 countries



The Headquarters of ACO Group in Rendsburg / Buedelsdorf, Germany



ACO Academy

Hans-Julius and Iver Ahlmann managing directors of ACO Group



How can ACO help?

As a global leader in surface water management technologies, ACO takes a professional approach to all projects. Our many years of experience in building and reconstruction of infrastructure facilities, as well as our international expertise are the cornerstone of the innovative solutions that we develop alongside the experts in the field. ACO is a partner of the European standardization organizations and assists the development of concepts for safety and durability as well as environmental solutions for building road infrastructure.

ACO's team of engineers approaches each project individually and is available for support at every stage of the design, construction and maintenance of the facilities.

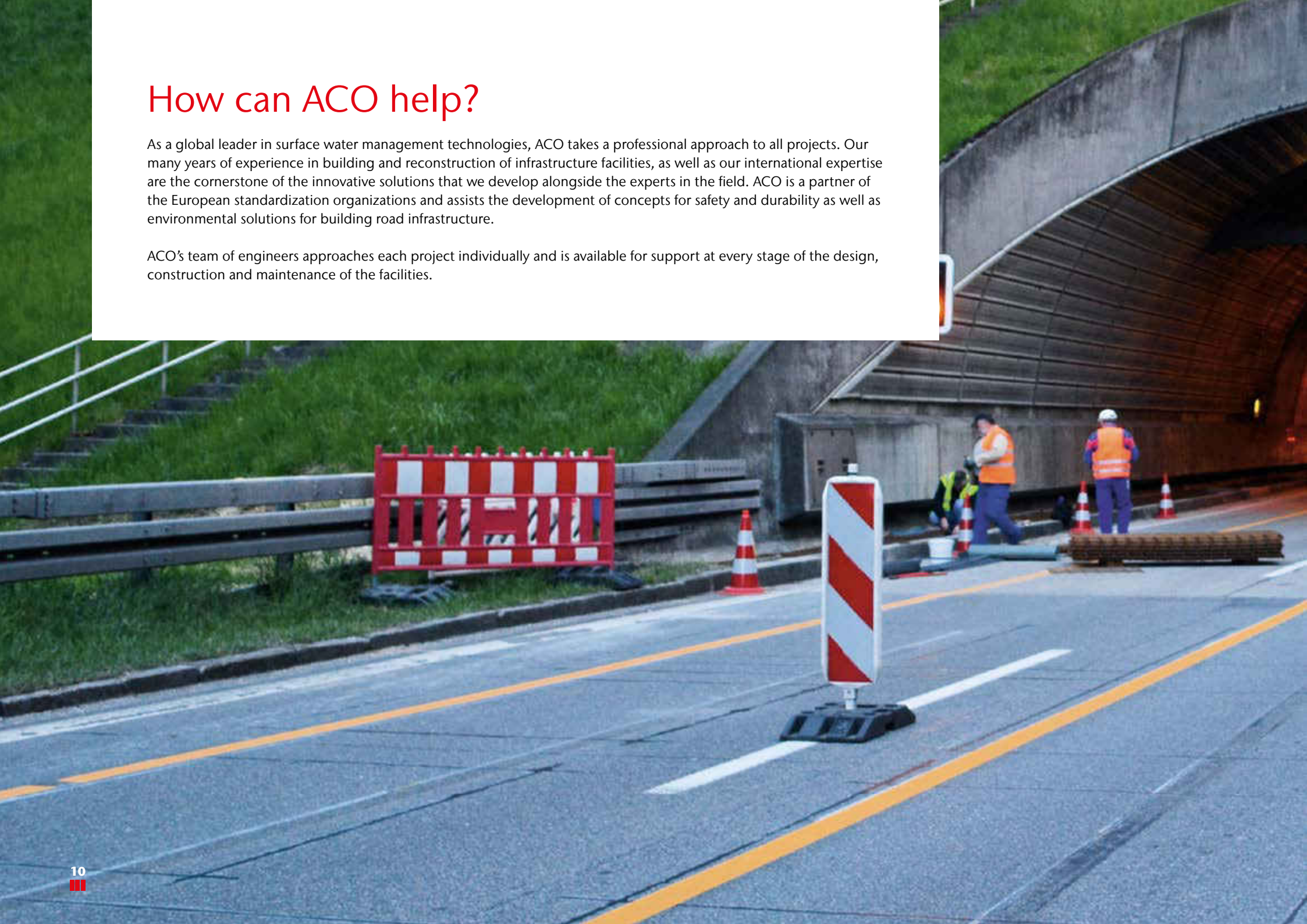





ACO Academy

The main goal of the ACO Academy is to be a valuable resource and a platform for all participants in the construction and investment process. Here you can learn about the most current best practices, projects norms and standards from your

colleagues as well as from international experts. By creating an open-door atmosphere, we stimulate networking and discussions on a personal and group level so we can resolve the challenges together and find new opportunities to apply the

latest innovations for creating a modern and safe infrastructure.

ACO's services - another advantages for sustainable system solutions



Information and further education

- Global trends
- Sustainable solutions
- Innovations
- Product trainings
- European norms
- Local regulations



Planning and optimisation

- System solutions
- Product and installation details
- Hydraulic and static calculations
- Specifications
- Project optimization
- European norms
- Local regulations



Construction advice and assistance

- Project supervision
- Installation trainings
- Installation instructions
- Technical documentation



Inspection and servicing

- Project supervision
- Maintenance trainings
- Maintenance instructions
- Maintenance
- Warranty service



1

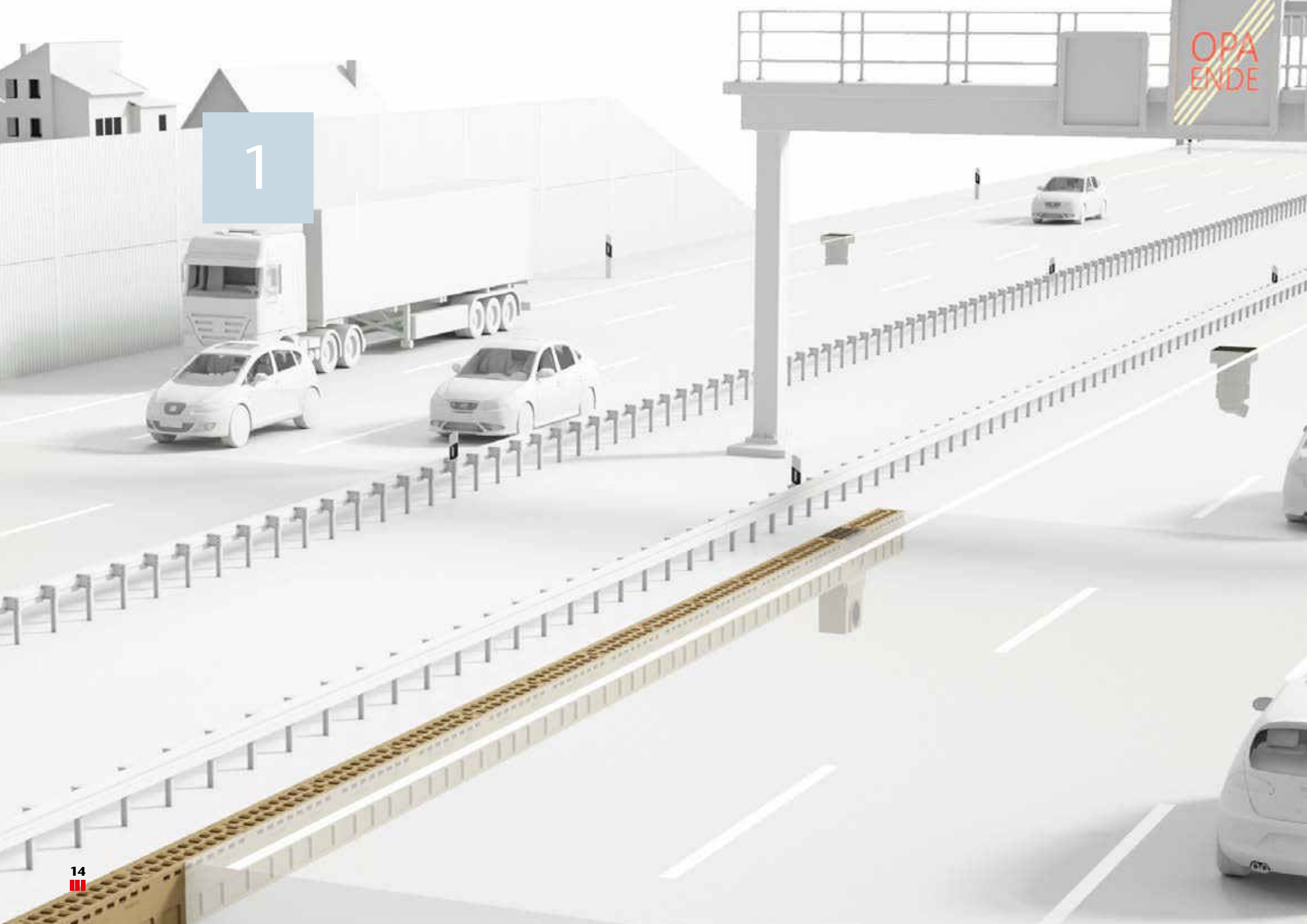



ACO Solutions for Highways

Drainage systems for highways include solutions for applications with intensive traffic, as well as parking and service areas. Durability and safety are top priority and the main requirement for drainage systems is the effective collection of surface waters. Modern norms and regulations put special focus on treatment of surface waters from light liquids, such as oil or heavy metal particles before releasing into sewer systems or in nature.

Challenges for highways design, construction and maintenance

1

Aquaplaning

The passing of water across the carriageways with a changing slope in the transition curve is a prerequisite for aquaplaning and one of the most common causes of accidents.



2

Water retention on the carriageway

In cases of slight longitudinal slope or in the horizontal curve zones, it is possible that water is retained in the fast lane or on a larger part of the carriageway.



3

Hazardous substances spillage and heavy metal pollution

In case of incidents and spillage on the highway, hazardous substances can contaminate the adjacent soil and water bodies. Heavy metal emissions from the tyres and braking systems of moving vehicles are also dangerous for the soil and water.



European norms and regulations



ORDINANCE No. RD-02-20-2 from 28.08.2018 for road design:

Art. 213 (2) The drainage gutters and the water collecting shafts to them shall be designed from watertight and frost-resistant material, resistant to all weather conditions without additional coatings - cold, freezing / thawing cycle and thawing substances.

(3) For motorways, expressways and two-lane roads, as well as for cross-laying on other types of roads, monolithic systems are used to prevent accidental opening and to secure against vandalism. Monolithic systems can be one-part drainage gutters or drainage curbs. In order to prevent water from entering the earth's body, all drainage gutters must be watertight, as well as at the connection of the elements.

ACO System solution

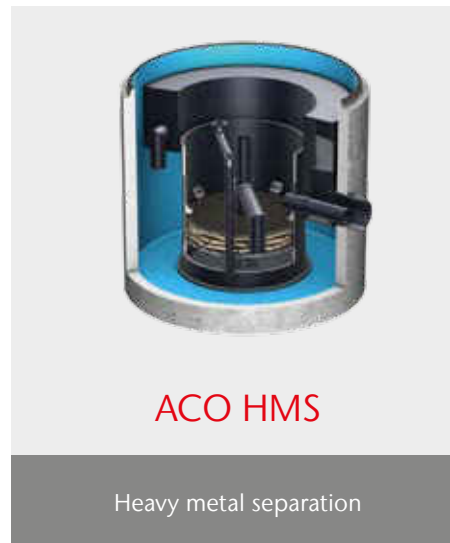





Highways

ACO Monoblock

Monolithic drainage channels

ACO Monoblock is a drainage channel that is manufactured to withstand extreme conditions owing to innovative manufacturing technology. Due to its monolithic structure the ACO Monoblock system guarantees optimal stability and protection against vandalism. The high resistance of the channel to high intensity dynamic loads and the lack of removable components make the system a preferred solution for longitudinal drainage of highways across the world.

ACO Monoblock

Advantages of the system

- Monolithic system for transverse and longitudinal drainage
- For the highest load class F900 according to BDS EN 1433
- Inbuilt rubber seal
- Manufactured from polymer concrete for low weight and high chemical resistance
- V-shaped cross section for maximum hydraulic capacity and self-cleaning effect
- Watertight and smooth material
- Options for inbuilt slope
- Easy access and maintenance

Monolithic channel

One-element sump unit with pipe connection

Optional side openings for drainage of porous surfaces and coatings

660mm-element access unit as well as for angular, T-shaped or crosslinked connection



1.0 m element



Sump unit



End cap



End cap with horizontal outlet







Highways

ACO KerbDrain

Combined kerb and drainage system

ACO KerbDrain is a monolithic system that combines a kerb and a drainage channel. The system was developed according to the requirements for functionality, safety and aesthetics of modern infrastructure.

ACO KerbDrain allows freedom in the designing and shaping roads and car parks. The system received the Queen's Award for Enterprise: Innovation in 2001 in Great Britain.

ACO KerbDrain

Advantages of the system

- An elegant solution combining kerb and drainage in one system
- Possibility for different sizes and kerb profiles
- The ideal solution for flat surfaces with longitudinal slope $\leq 2\%$ or very steep areas
- Eliminates the need for point drainage and leaves the surface clear of any gratings
- Vandalism-proof, without moving parts due to its monolithic structure

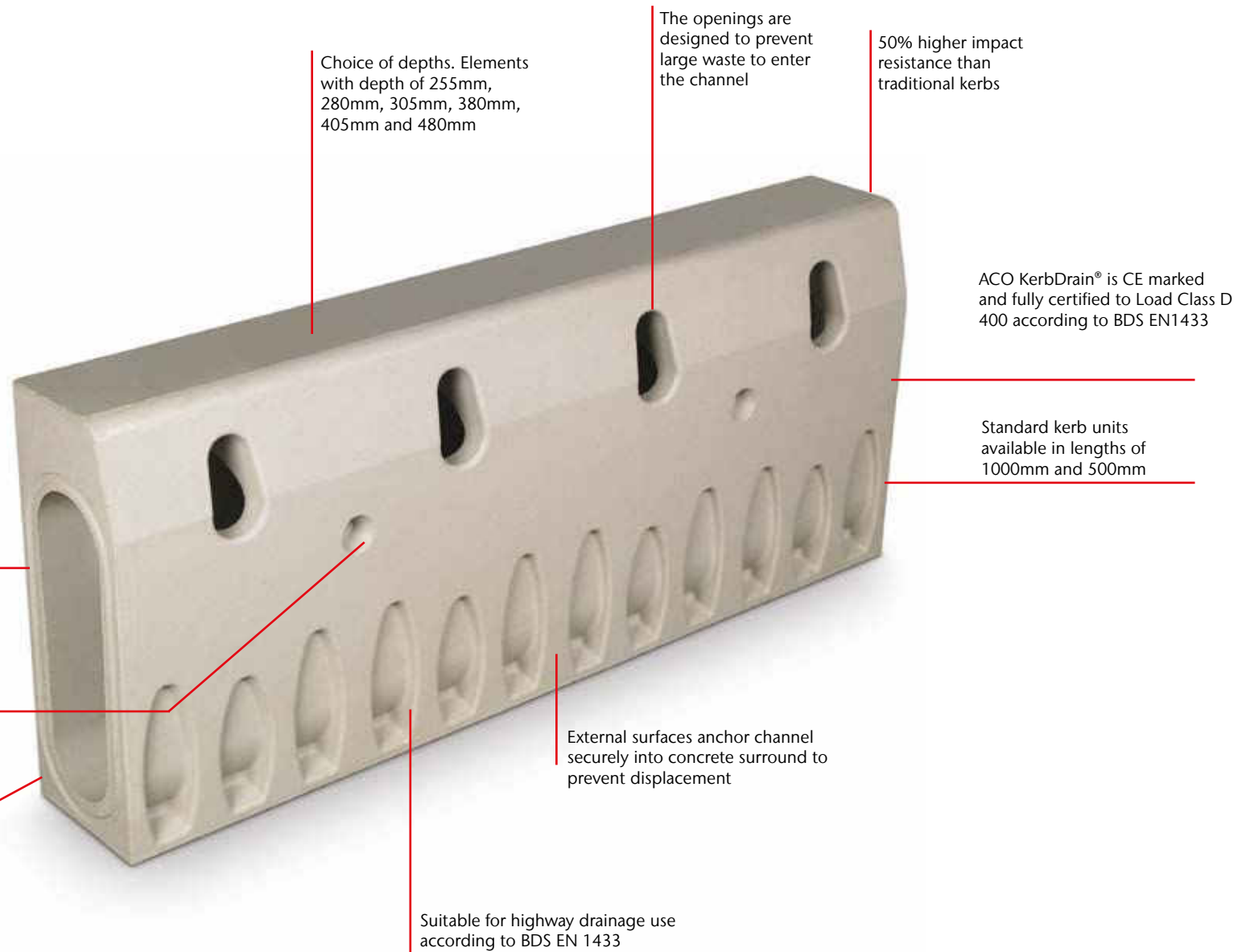



Sump unit



Revision element



SP - splay kerb for drainage of highways







Highways

ACO Qmax

Slot drainage with high hydraulic capacity

ACO Qmax is a slot drainage system that ensures the highest hydraulic capacity. This intelligent system is designed for the effective storage, retention and release of large quantities of rain water.

ACO Qmax® meets the requirements for a flexible slot drainage system for the highest load class F900.

ACO Qmax

Advantages of the system

- Manufactured from MDPE for strong and corrosion resistant structure
- Optimal cross section for maximum hydraulic capacity and self-cleaning effect
- Certified for highest load class F900 according to BDS EN 1433
- Choice of three different edge rails according to the surface
- Choice of six different sizes for optimal drainage for step system installation

Patented "Pavement beam" feature permits continuous flow of concrete through the system for strong and economic installation

Lightweight material and design for easy manual handling and fast installation

2.0m elements for minimum connections and fast installation

Channel provided with all components

The ACO Qmax® 550, 700 and 900 channels are provided with wingnut connection

Simple push fit channel connection detail for easy edge rail alignment

Integrated channel seal for quick and easy watertight connections

Channels can be cut at predetermined lengths

Ultra stiff rib design for high strength during handling and installation

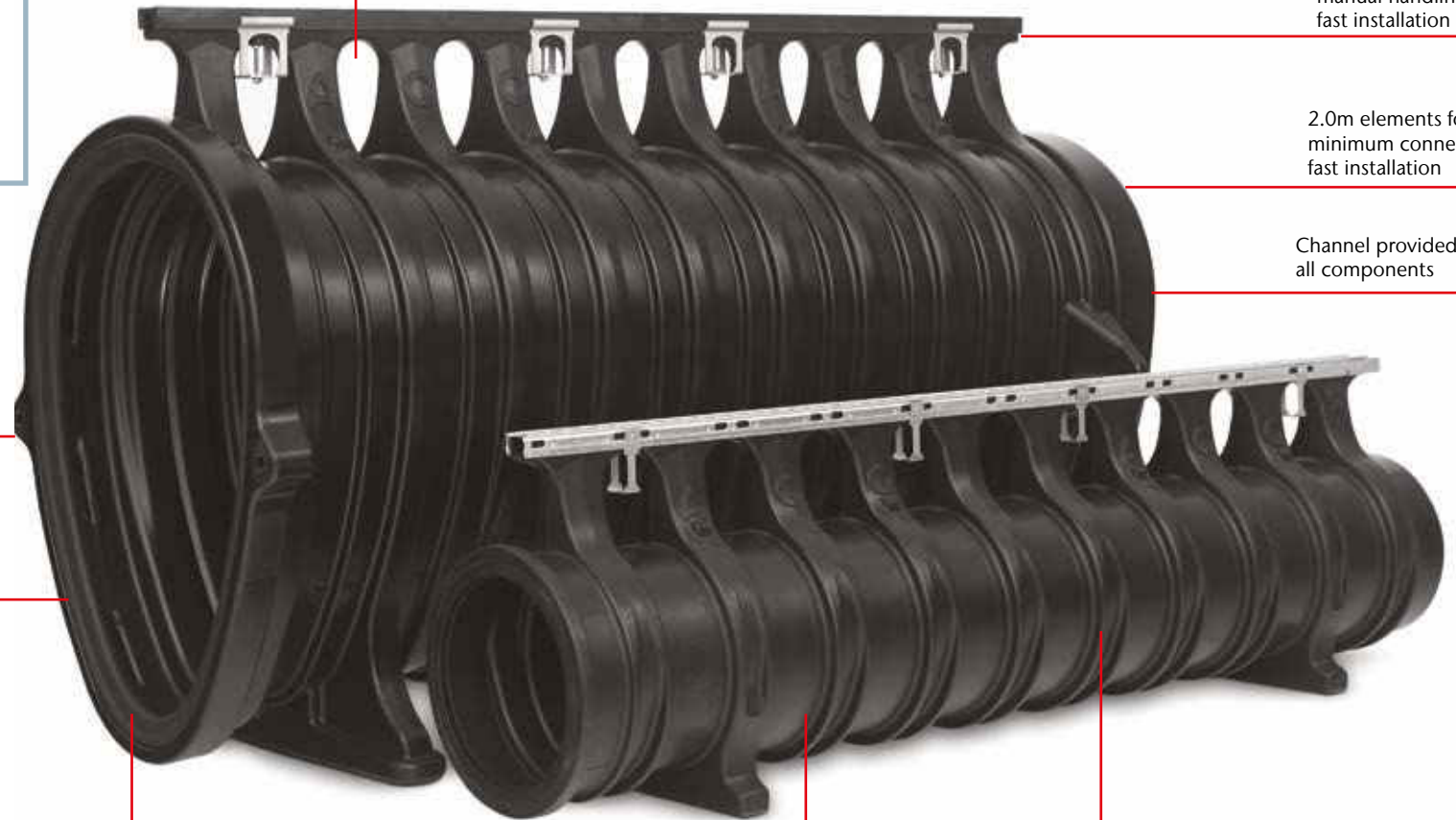



Access chamber



End caps close the system
or provide connection to
drainage network



MDPE connectors for step system
design and uninterrupted finish







Highways

ACO Oleopator G-H

Light oil separator from glass reinforced plastic

The main objective of sustainable drainage systems is the treatment of surface waters as close as possible to the source of pollution. Oil separators effectively separate all petroleum products in the surface water and stop them from being transferred to nature where they will be a danger to the environment. The light oil separators manufactured from glass reinforced plastic are a suitable solution for water purification from highways.

ACO Oleopator G-H

Advantages of the system

- Manufactured from glass reinforced plastic
- Low weight and long lasting
- Possibility for deeper installation
- High resistance to chemicals
- Proven effectiveness by an independent

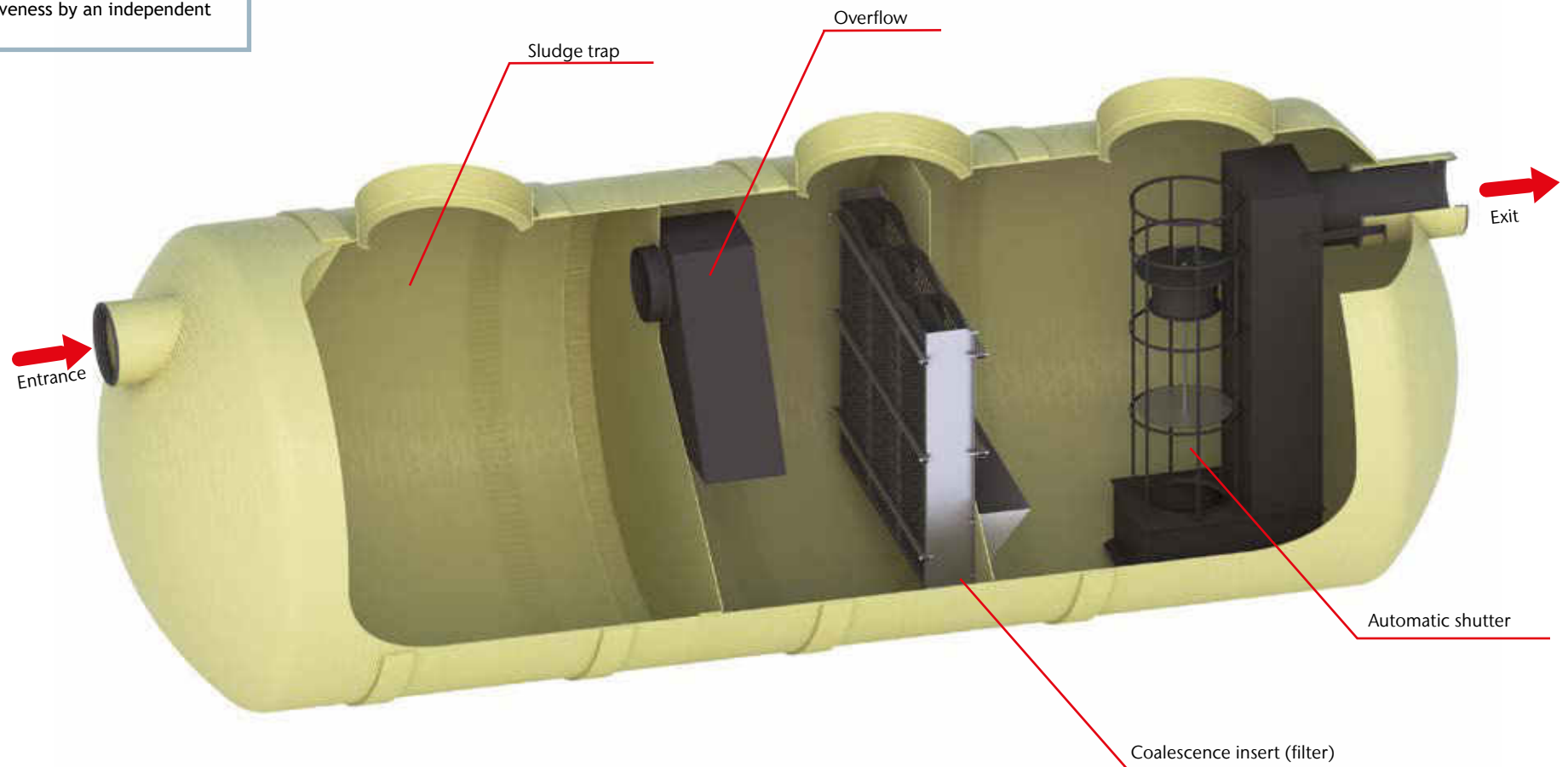



Upper part with frame and cover for load class A15 according to BDS EN 124



Upper part with frame and cover for load class B125 according to BDS EN 124



Upper part with frame and cover for load class D400 according to BDS EN 124



Automatic signaling device with GPS connection and SMS notification



Anti-flotation polyester belt

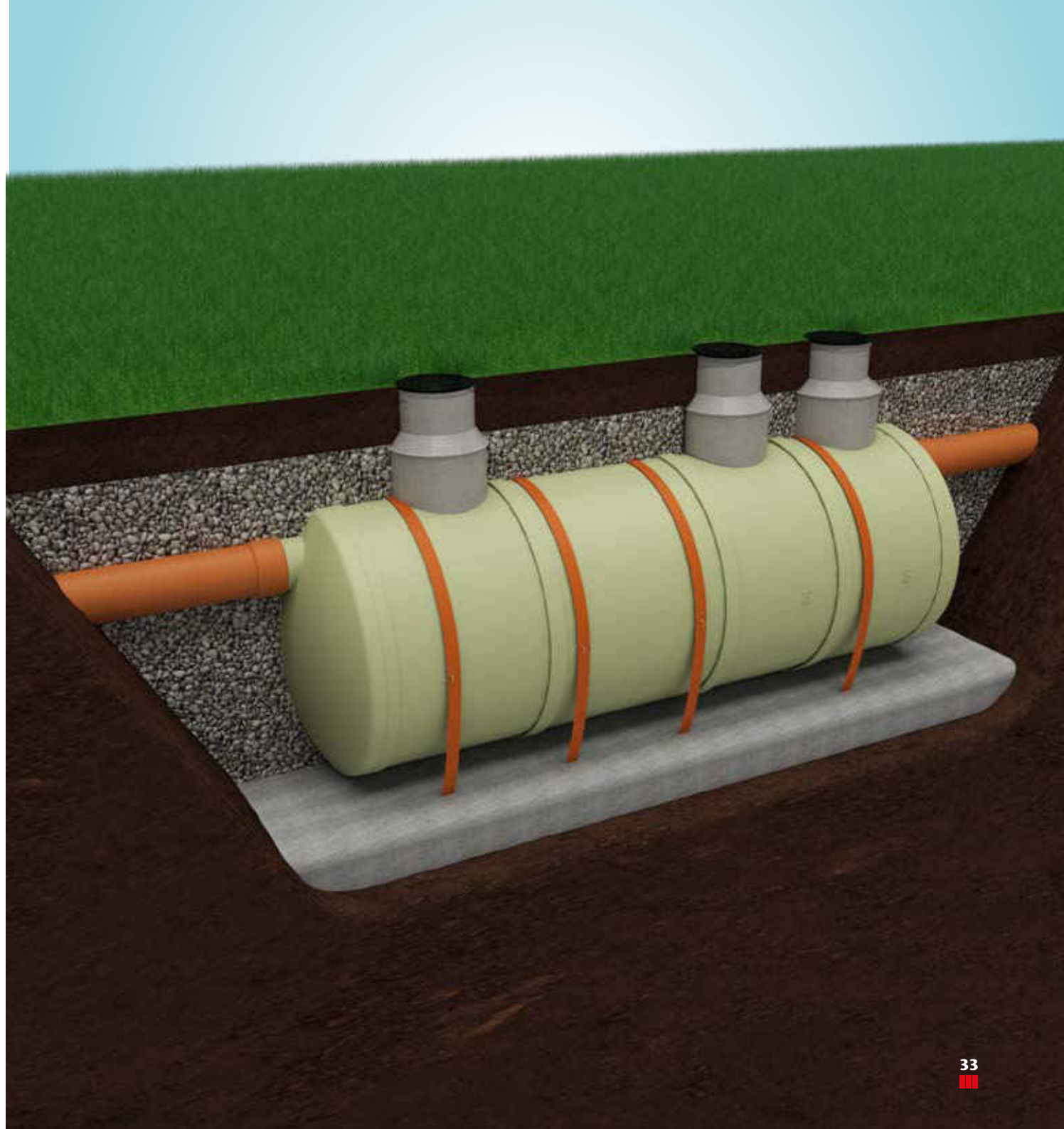





Highways

ACO Stormclean

Technical filter

ACO Stormclean TF cleans rainwater from surfaces that are frequently used by all types of vehicles including heavy goods traffic. The filter removes rainwater contaminants including mineral oils and heavy metals collected from traffic areas. ACO Stormclean TF uses a highly reactive filter material to adsorb these substances and is particularly effective at removing TSSs suspended solids with a particle size of less than 63 microns. TSSs are captured by the filter material to protect the groundwater from contamination.

ACO Stormclean Technical Filter

Advantages of the system

- Simultaneous water cleaning via the removal of mineral oils, heavy metals and suspended solids
- Optimal accessibility for maintenance, cleaning and disposal
- Made from glassfiber - light as plastic, strong as concrete
- Tested filter life of up to four years (depending on the type of pollution being filtered)
- Allows water infiltration into soil, reducing the need of additional treatment and public sewer systems
- Quality of treated water is suitable for infiltration
- Tested in compliance with the strictest European norms

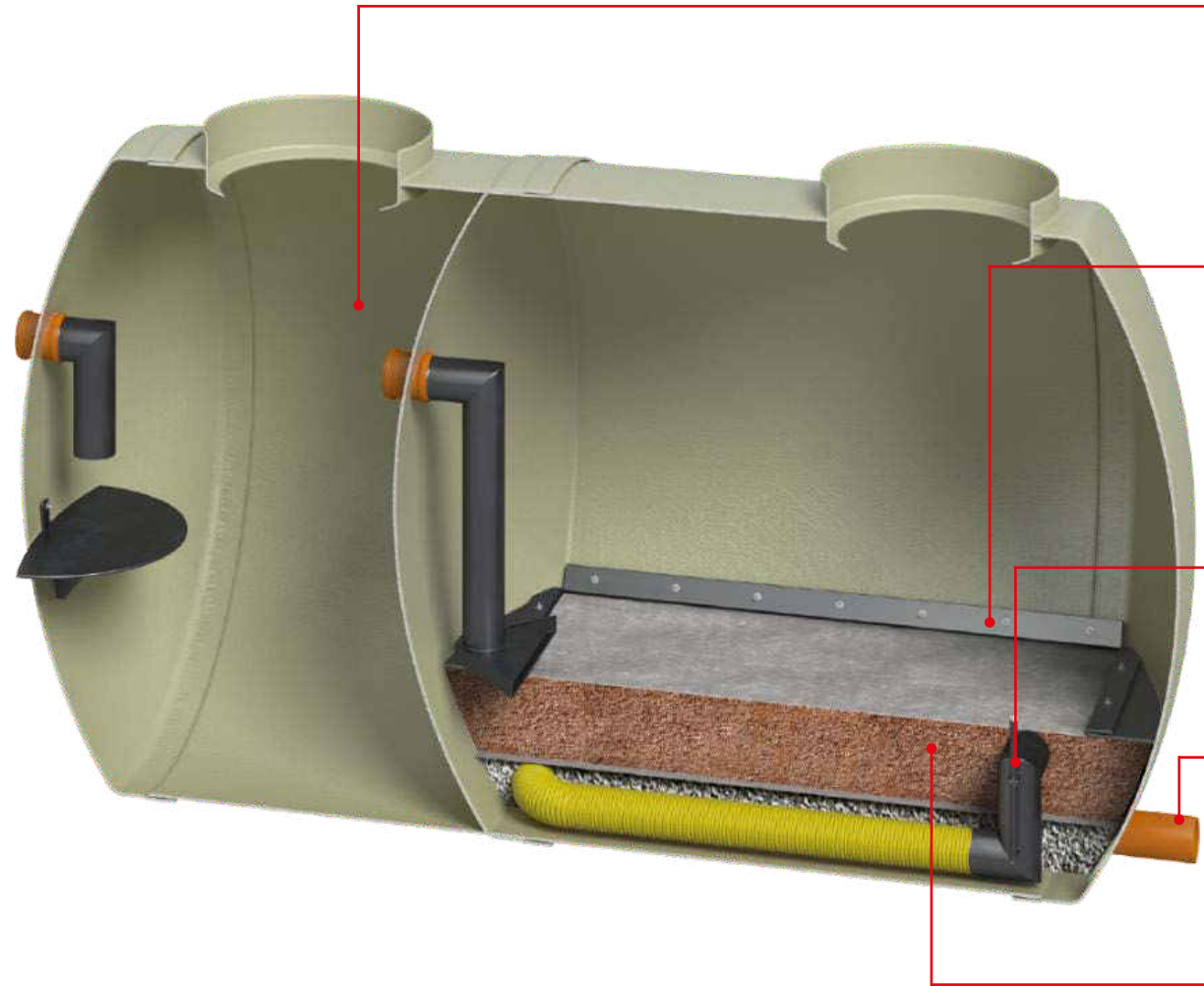

Operational capacity
Filter equipment
Catchment area

1:250

Sludge pre treatment

Integrated sludge trap with higher size (Qx150) to ensure all bigger particles and sludge are removed before contact with filtermedia

Fixation bars

Plastic inserts ensure transport stability fixation of the material during operation and allows easy exchange of filter media and geotextile when needed

Sampling unit

All Stormclean products contain a sampling unit to take samples during operation from ground level

Flexible solution

Outlet pipe position could be changed to meet the requirements of Stormbrixx (SD/HD) installation depth

Filter media

The filter removes rainwater contaminants including mineral oils and heavy metals collected from traffic, industry or roofs. Highly reactive filter material also filters and retains suspended solids (TSSs) with a diameter of less than 63 microns.

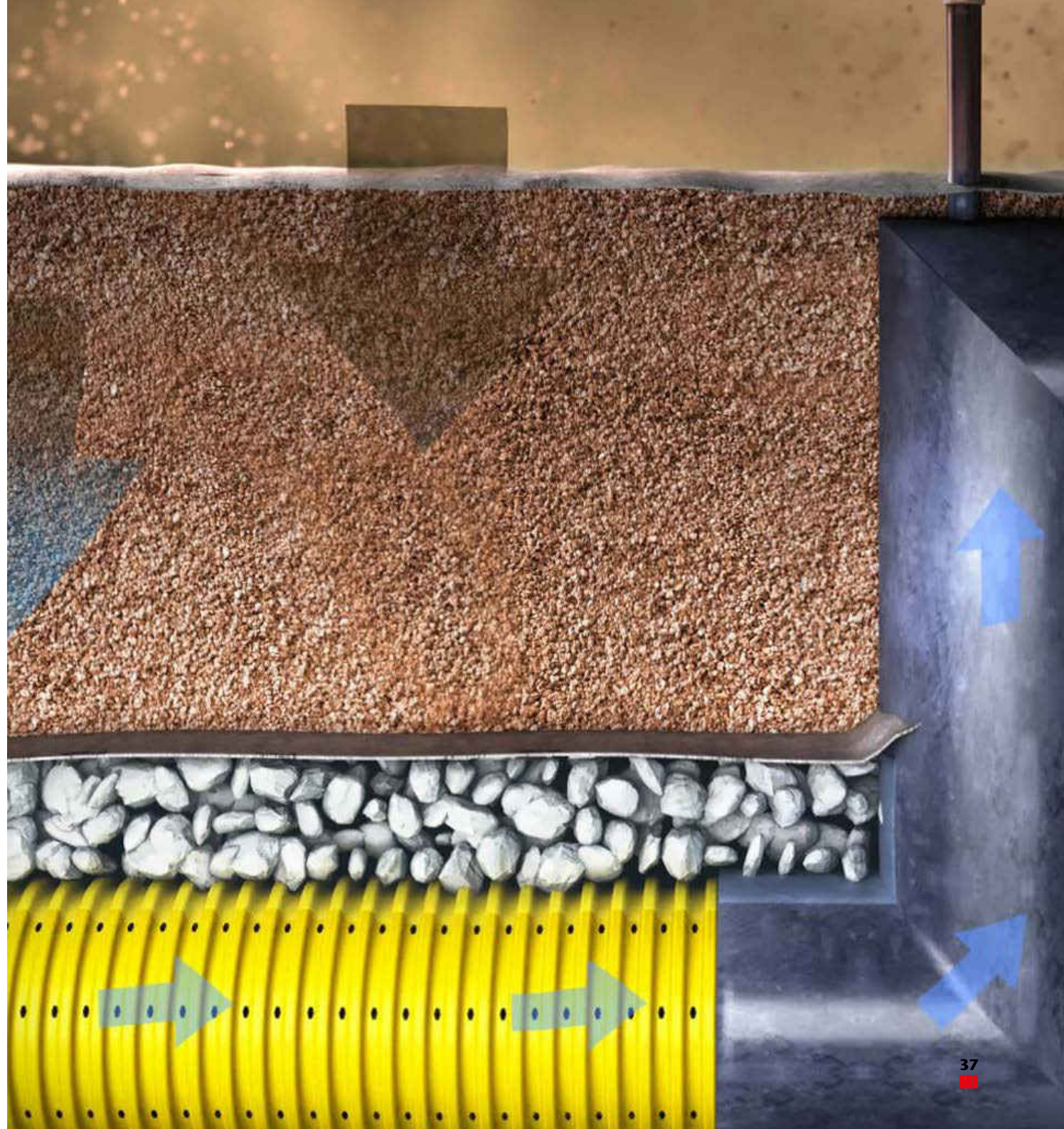





Highways

ACO HMS

Heavy metal separators

Surface waters from highways potentially contain heavy metal particles coming from vehicle brake systems. If those particles are not filtered they are danger for the soil and ground waters, as well as plants around the highway. ACO Heavy metal separators as integral part of surface water treatment system for environmental protection.

ACO HMS

Advantages of the system

- Manufactured from reinforced concrete
- Big installation depth
- Proven effectiveness by an independent supervision organization
- Compact size
- With built-in bypass

Multi-layer individual stretch filters



With a three-layer inside protective coating for high chemical resistance

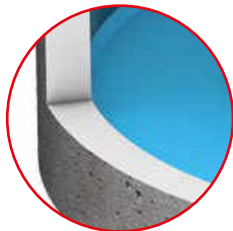

Integrated rubber sealing

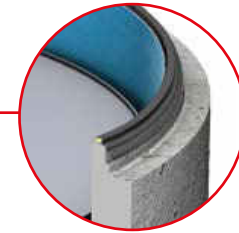

Sediment net with integrated load distribution

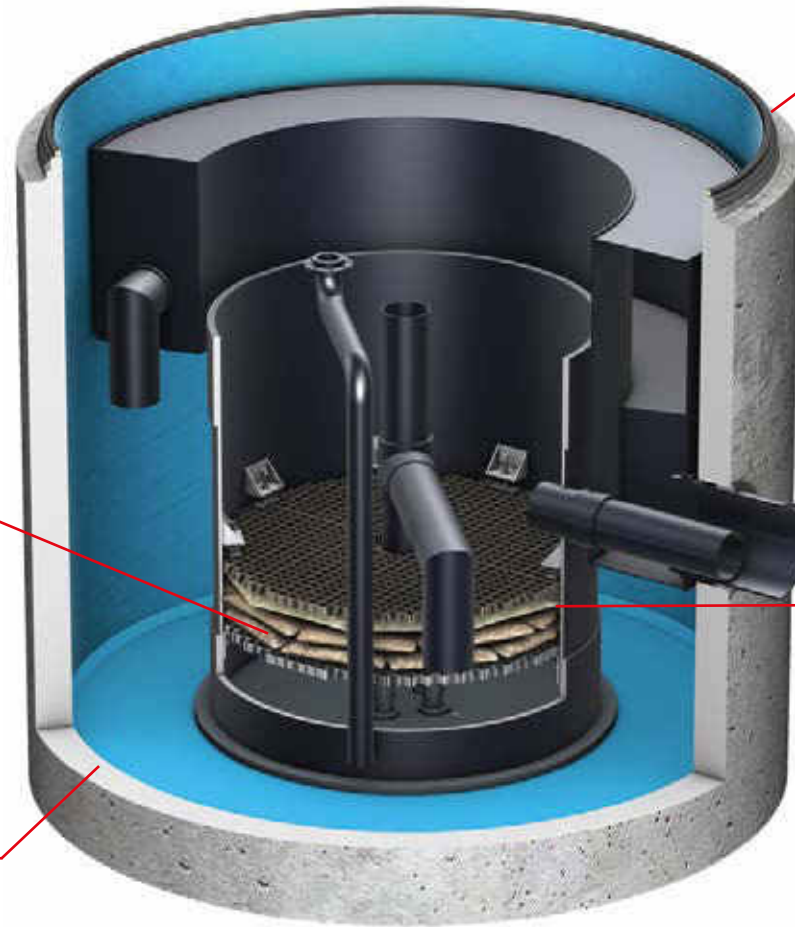



Upper part from reinforced concrete with transition plate and cast iron manhole cover, load class D400 according to EN 124



Underlying reinforced concrete ring for levelling of the surface of the manhole cover



Shaft ring with socket and gasket from reinforced concrete for levelling of the surface of the manhole cover

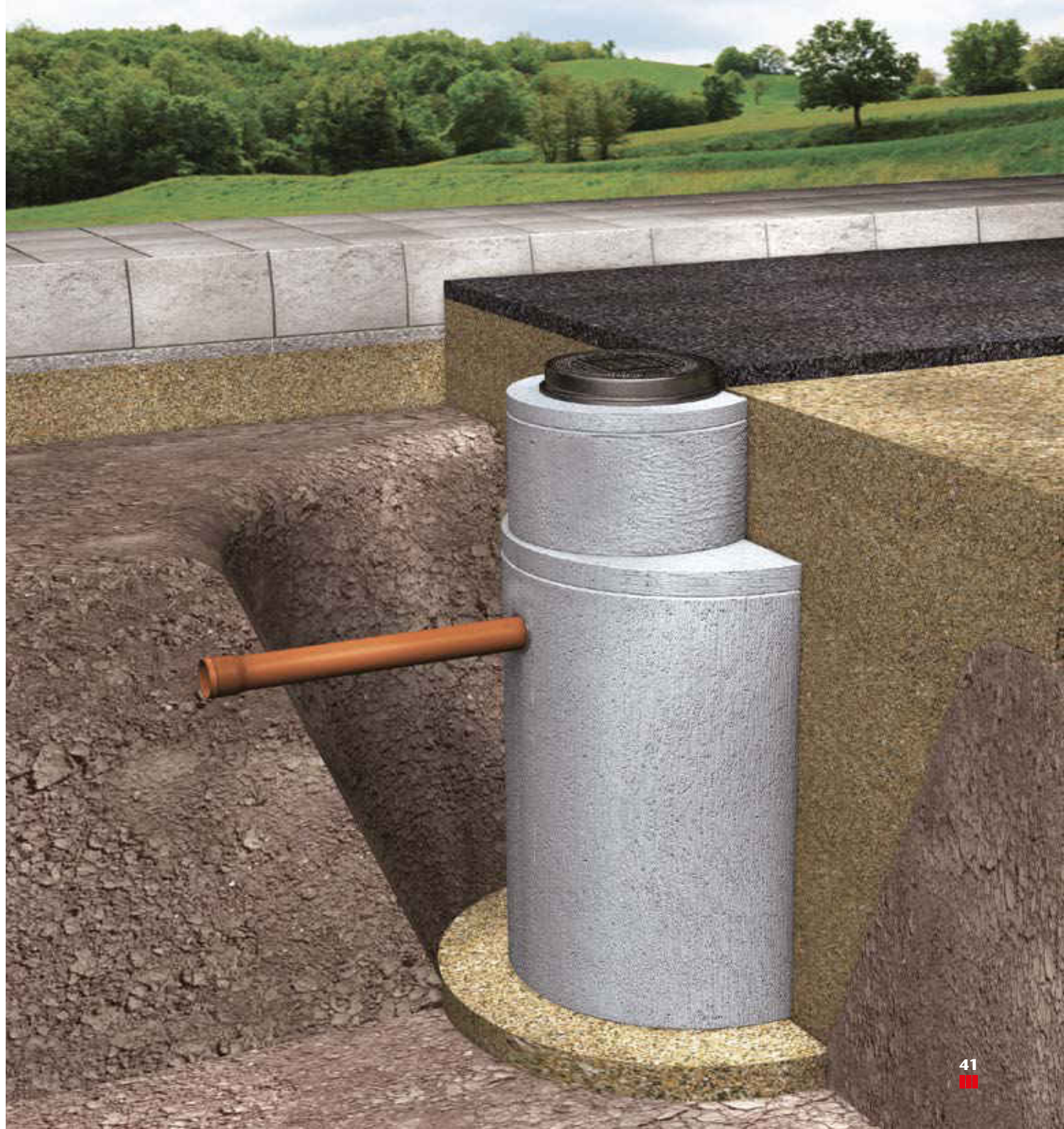





Highways

ACO Stormbrixx SD

Surface water infiltration and storage system

ACO Stormbrixx is a practical and environmentally friendly solution for projects where there is no sewage system on site or the existing system has limited capacity. The system can be used for infiltration or storage and controlled discharge of rain water. At the same time, it also helps conserve the natural water cycle as recommended by EN752.

ACO Stormbrixx SD

Advantages of the system

- Structural stability
- Inspection access to the whole system
- Light easily connectable elements for fast and easy installation
- High storage ratio
- Sustainable solution for highways, car parks and other areas where water infiltration is needed (alternative solution to an evaporation tank)



Body element



Option to install 1/2 layer



Top cover

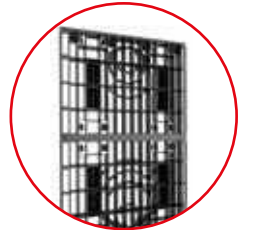

Side panel

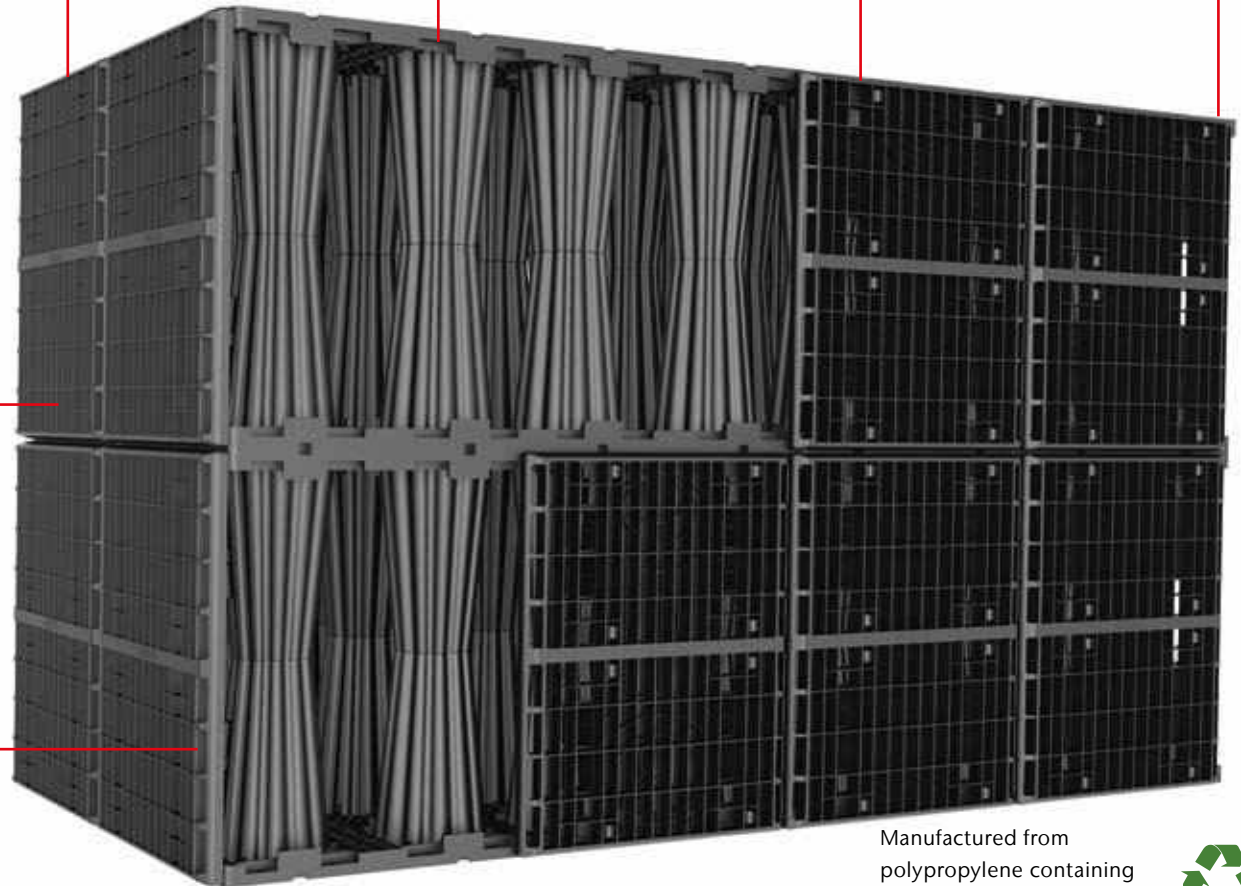

High void ratio of 95% results in better storage and optimal filling of the system



The open structure of ACO Stormbrixx allows free access for inspection and cleaning

Manufactured from polypropylene containing recycled materials.





Manhole cover



Inspection point
upper part



Access plate



Clip-on connectors for optimal stability when connecting layers of ACO Stormbrixx

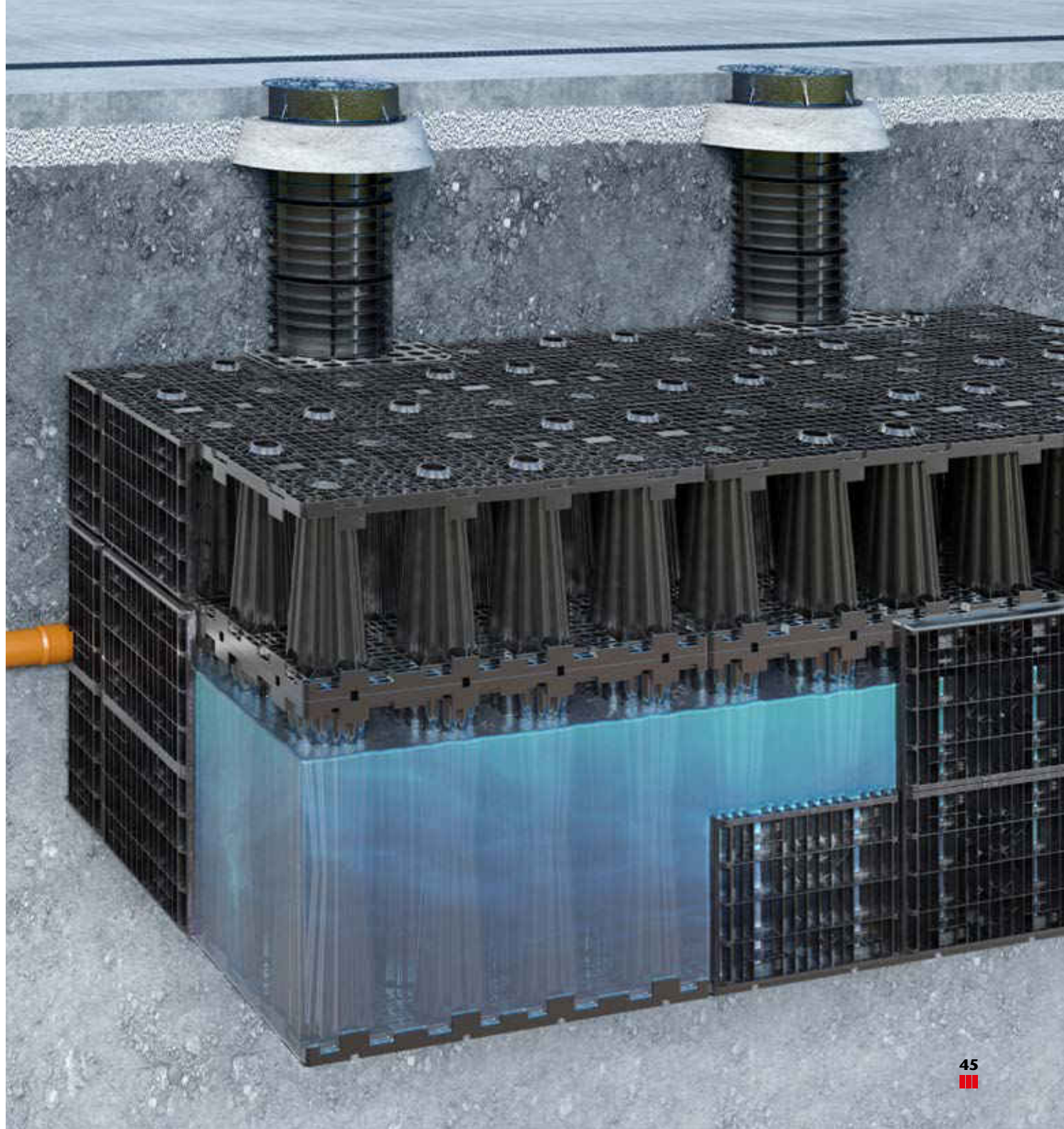

ACO Reference projects:
Highways





Hemus Highway, Bulgaria

Investor:
Road Infrastructure Agency

ACO Solution:

- ACO Monoblock



ACO Reference projects:
Highways





Struma Highway, Bulgaria

Investor:

Road Infrastructure Agency

ACO Solution:

- ACO Pipe
- ACO Multi Max F
- ACO Clara
- ACO Oleopator G
- ACO Highdrain Gullys
- ACO Monoblock
- ACO Multitop Bituplan



ACO Reference projects:
Highways





Trakia Highway, Bulgaria

Investor:
Road Infrastructure Agency

ACO Solution:
■ ACO Monoblock



ACO Reference projects:
Highways





Highway Sela,
Ajdovščina, Slovenia

Investor:

ACO Solution:

- ACO Monoblock
- ACO Combipoint



ACO Reference projects:

Highways





Vrčin Pay Toll, Serbia

Investor:
JP Putevi Srbije

ACO Solution:

- ACO Qmax



ACO Reference projects:

Highways





**Castello autostradale
Meolo, Italy**

Investor:
Autovie Venete

ACO Solution:

- ACO Monoblock RD



ACO Reference projects:
Highways





M0 Highway, Hungary

Investor:
NIF

ACO Solution:

- ACO Monoblock RD



ACO Reference projects: Highways



E-80 Koridor 10 Pirot-Sukovo, Serbia

Investor:
Vlada Srbije

ACO Solution:

- ACO Qmax
- ACO Gratings F900

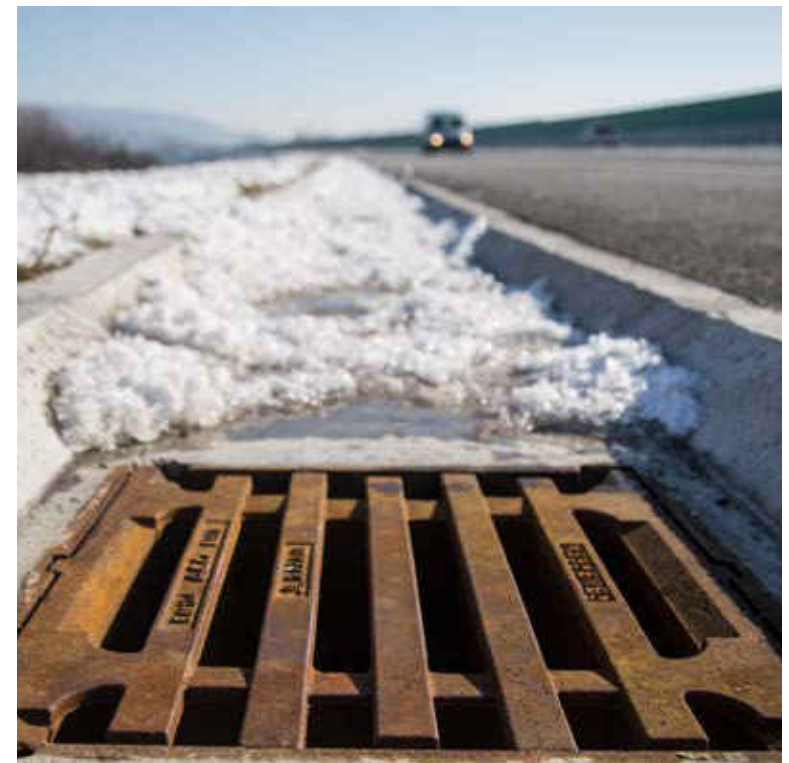



Autobahn A4, Austria

Investor:

ACO Solution:

- ACO Monoblock RD



ACO Reference projects: Highways



Center for organization
and traffic control, Croatia

Investor:

Hrvatske Autoceste d.o.o

ACO Solution:

- ACO Monoblock
- ACO Comb Rail





Highway Lay-by Lormanje, Slovenia

Investor:
DARS d.d.

ACO Solution:

- ACO Monoblock



2





ACO Solutions for Tunnels

Designing and construction of tunnel drainage systems require special focus on safety, fire resistance and easy maintenance. ACO offers innovative high-quality solutions and professional expertise, according to the requirements of the European and local regulations.

Challenges for the design, construction and maintenance of tunnels

1

Spillage of dangerous substances

In case of incidents in the tunnel, the removal of flammable liquids from the road surface as fast as possible reduces the risk of fire.



2

Chemical resistance

The use of aggressive de-icing substances and the incidental spillage of dangerous substances on the road lead to the destruction of materials with low chemical resistance.



3

Fire safety

The construction of fire compartments prevents the spread of fire or flammable liquids. This protects people in the tunnel, as well as expensive structures and installations.



European norms and regulations



ORDINANCE No. RD-02-20-2 of 21 December 2015 on technical rules and regulations for the design of road tunnels

Art. 147. (1) For fast removal of Art. 147.
(1) For fast removal of the combustible, explosive or toxic liquids from the roadway shall be provided slotted (with a slot) drainage gutters, which shall also serve for restriction of the roadway.
(2) The liquids shall be discharged into a closed system. The following measures

are planned and implemented to prevent explosion:
1. use of a shaft with a hydraulic shut-off (siphon type), which prevents the return of explosive gases in the space from the tunnel intended for the movement of vehicles; the shaft must be hermetically sealed; the siphons must always be full and prevent oxygen from entering the collector;
(8) Drainage gutters are designed with a rounded cross section according to the slope and the maximum amount of water they will conduct. The width of the water intake must be at least 100mm.

ACO System solution

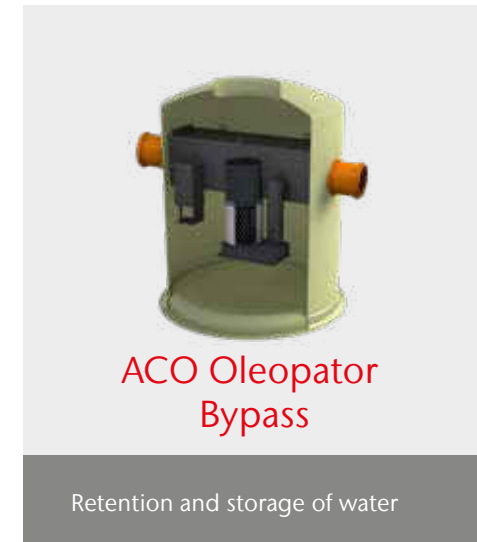





Tunnels

ACO ProTunnel

Specialized system for tunnel drainage

ACO ProTunnel is a monolithic slot drainage channel for application in tunnels.

It's a channel and syphon shaft system for the quick removal of dangerous liquid spillages from the road surface in case of incidents.

Manufactured from polymer concrete for extremely high chemical resistance, with low weight and optimal size.

Certified according to the European directive for tunnels 2004/54/EC and German regulations RABT and ZTV-ING.

ACO ProTunnel

Advantages of the system

- Hydraulic software for defining the zones and configuring the system
- Syphon shaft for quick removal of dangerous substances and cutting the access of oxygen
- Watertight system with integrated impact sealing resistant to oils and fuels
- Wide slot for fast and effective mechanized cleaning
- From polymer concrete for low weight, extremely high chemical resistance and optimal size
- Frost-resistant and also resistant to de-icing chemicals

3.5m length for easy and fast installation

Wide 100mm slot for optimal mechanized cleaning

One element with two functions - restricting and removing dangerous substances

Integrated sealing

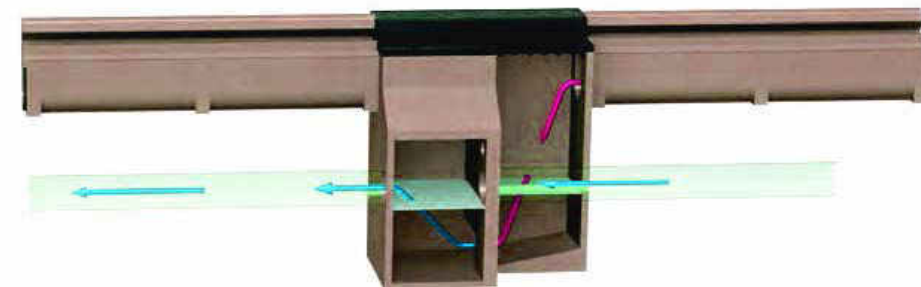

Syphon shaft
With integrated sealing
Tight covers for preventing the access of oxygen in the collecting system
Project-specific geometry option according to customer's requirements



Kerbstone



Inspection shaft



Collection shaft



Cable shaft



Shaft cover







Tunnels

ACO Multitop

Watertight self levelling manhole covers

All installations and structures in the tunnel have to comply with fire safety requirements. According to these regulations the shaft covers have to be watertight to prevent the possible spillages of dangerous liquids that might create a fire hazard or explosion.

ACO Multitop is a watertight cover for inspection shafts, specially developed for tunnels. Manufactured from spheroidal graphite cast iron (GJS), with integrated sealing resistant to oils and fuels. The system has three special locking devices for prevention of incidental opening or unauthorized access.

ACO Multitop

Advantages of the system

- Class D400 according to BDS EN 124
- Watertight system with integrated sealing resistant to oils and fuels
- Three special locking devices
- Spheroidal graphite cast iron (GJS) for many years of operation



Secret locking with three bolts



Opening mechanism



BEGU frame for easy lifting and resurfacing



Soundproofing pad from highly resistant PEWEPREN



Spheroidal graphite cast iron (GJS) cover



Cast iron ring (EN GJL)



Key for opening the bolt connection



Levelling wedges for installation





Maximum Ia
Starting Current Is
Nominal Current In
Protection IP
Dimensions

1,5 A
0,5 A
IP 68
M 25 x 1,5

5. Nach Handbetrieb elektrisch anfahren -
Acht / Zu - damit Kupplung einrastet!

ZU



Tunnels

ACO Emergency valve system

Valve for separating dangerous substances

In the event of an accident and spillage of dangerous liquids in the tunnel it is necessary that they are collected and retained to prevent them from entering in the sewage system or leaking into nature which can cause fire, explosion or environmental pollution. The ACO automatic valve system installed in the reinforced concrete shaft, closes within seconds after the fluids enter. The system guarantees durability, protection against explosion and allows the necessary installation depth.

ACO Emergency valve system

Advantages of the system

- Produced from reinforced concrete for durability
- Mechanism for protection against explosions
- Big installation depth
- Cover with load class D400 according to BDS EN124
- Produced from reinforced concrete for

Cast iron shaft cover, load class D 400 with sealing against gases



With additional exit for emptying the system



Automatic opening/ closing of the explosion protection valve



Stainless steel pipes

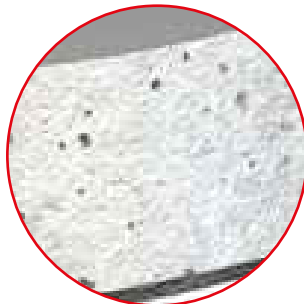

Reinforced concrete according to DIN 4281

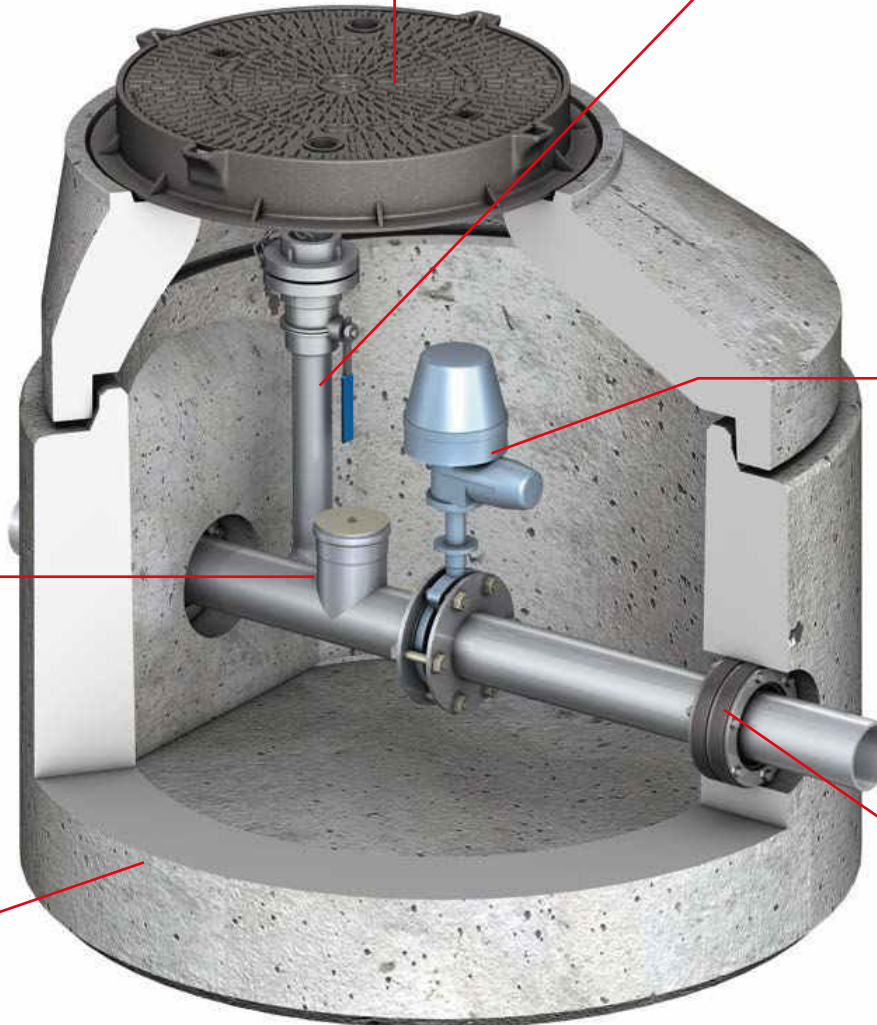

Watertight passage of the pipe



Automatic alarm system for controlling the thickness of the oil layer and the retained particles



Underlying reinforced concrete ring for levelling the surface of the shaft





eltrak

CAT

IN



Tunnels

ACO Oleopator-Bypass

Oil separators with integrated bypass

The main objective of sustainable drainage systems is the treatment of surface waters as close as possible to the source of pollution. Oil separators effectively separate all oils in the surface water and stop them from being transferred to the drainage system or in nature where they might be dangerous. Oil separators from glass reinforced plastic are a particularly suitable solution for water purification from tunnels.

ACO Oleopator-Bypass

Advantages of the system

- Storage of large volumes of liquids
- Manufactured from glass reinforced plastic
- Low weight and long lasting
- Big installation depth
- High chemical resistance

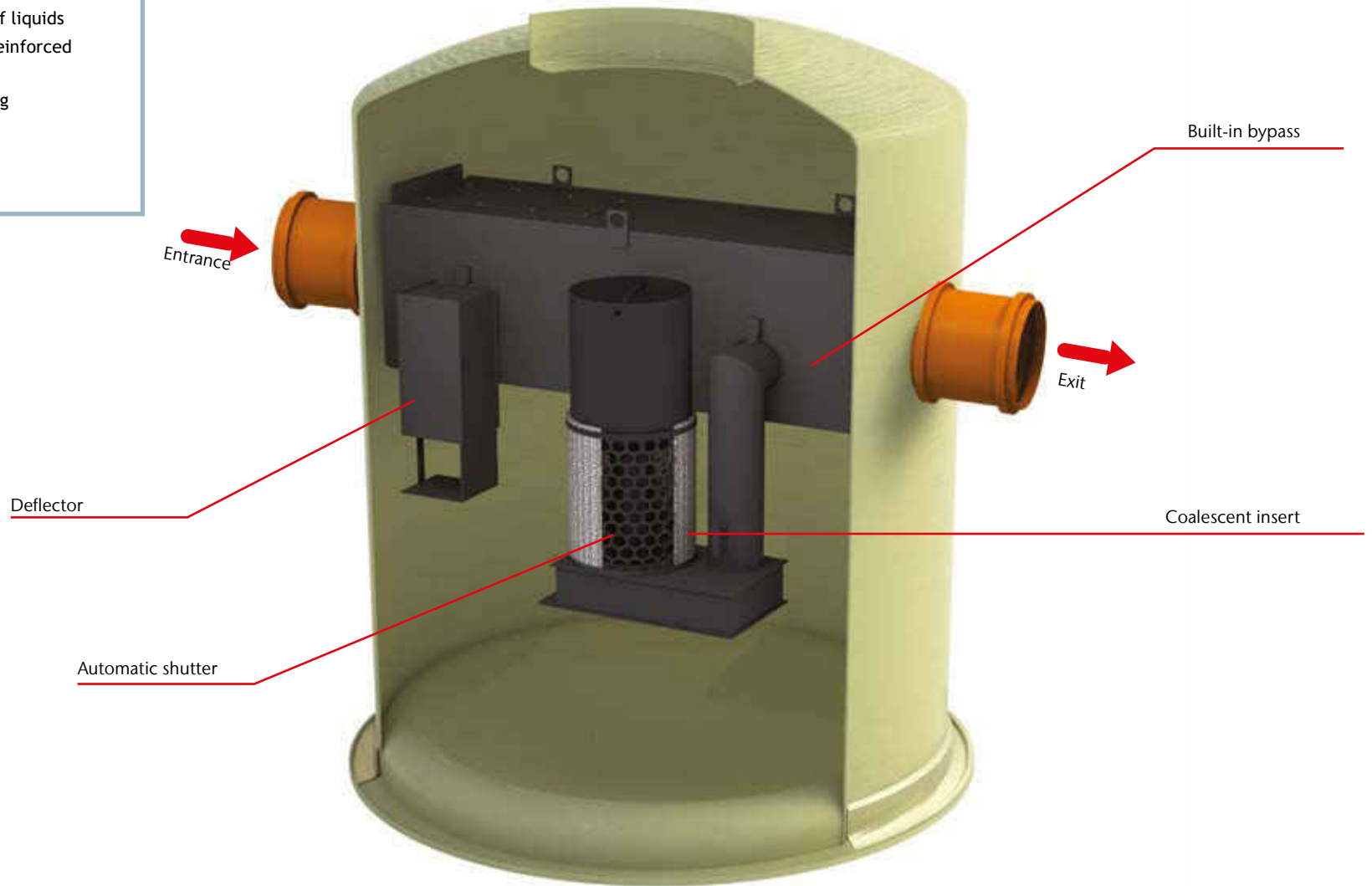



Upper part with frame and cover for load class A15 according to BDS EN 124



Upper part with frame and cover for load class B125 according to BDS EN 124



Upper part with frame and cover for load class D400 according to BDS EN 124



Automatic signaling device with GPS connection and SMS notification







Tunnels

ACO GRP Tank

Tank for collection of dangerous substances

In case of incident in a tunnel, the safety, environment protection and prevention of fire is of utmost importance. The ACO GRP Tanks for collection of dangerous liquids allow the collection and retention of dangerous fluids in case of accident. The glass reinforced plastic material guarantees high chemical resistance, ease of installation and easy maintenance. The stable structure of the tanks allows the installation at the required depth.

ACO GRP Tank

Advantages of the system

- Storage of large volumes of liquids
- Manufactured from glass reinforced plastic
- Low weight and long lasting
- Big installation depth

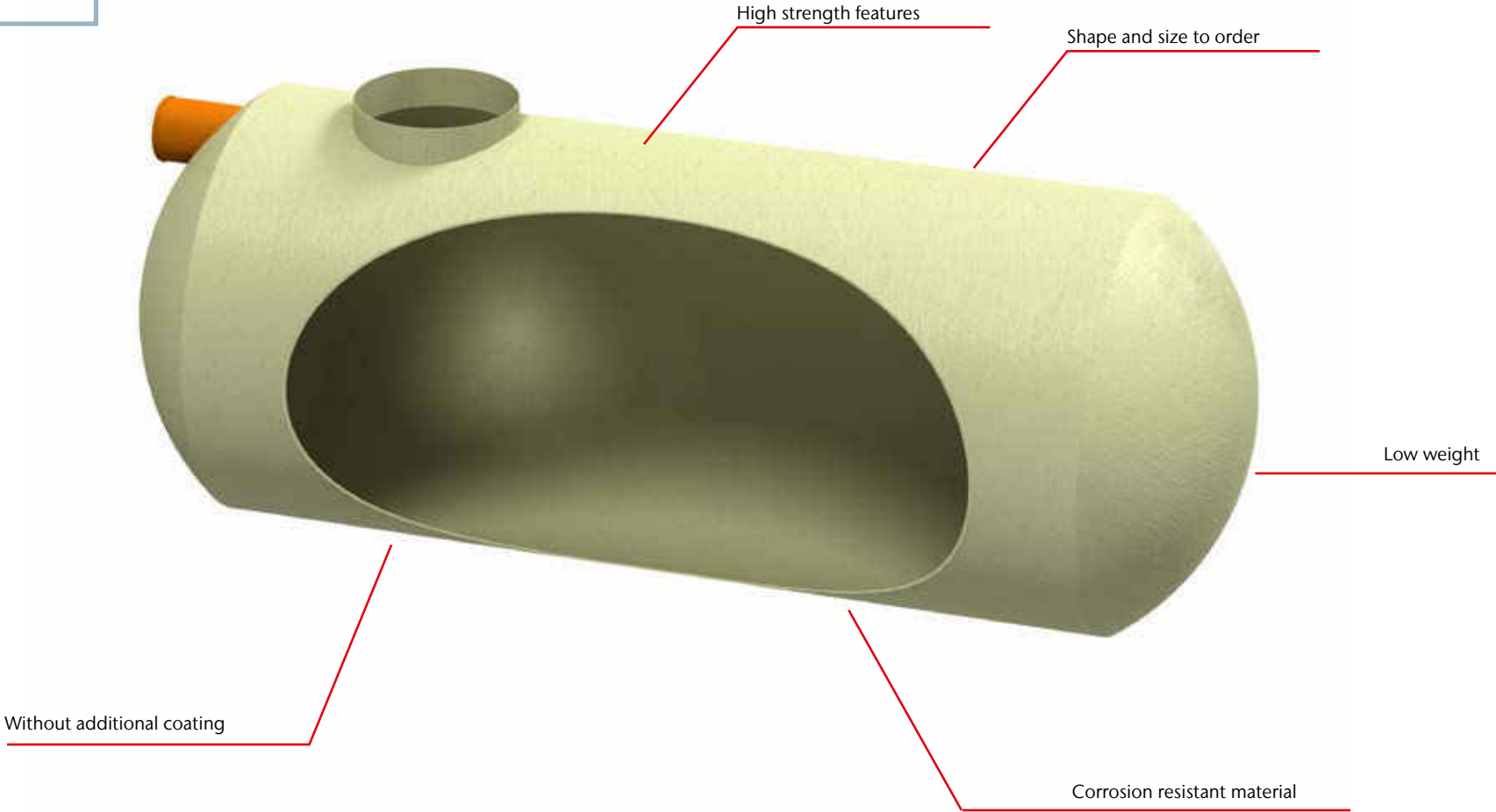



Upper part with frame and cover for load class A15 according to BDS EN 124



Upper part with frame and cover for load class B125 according to BDS EN 124



Upper part with frame and cover for load class D400 according to BDS EN 124



Anti-flotation polyester belt

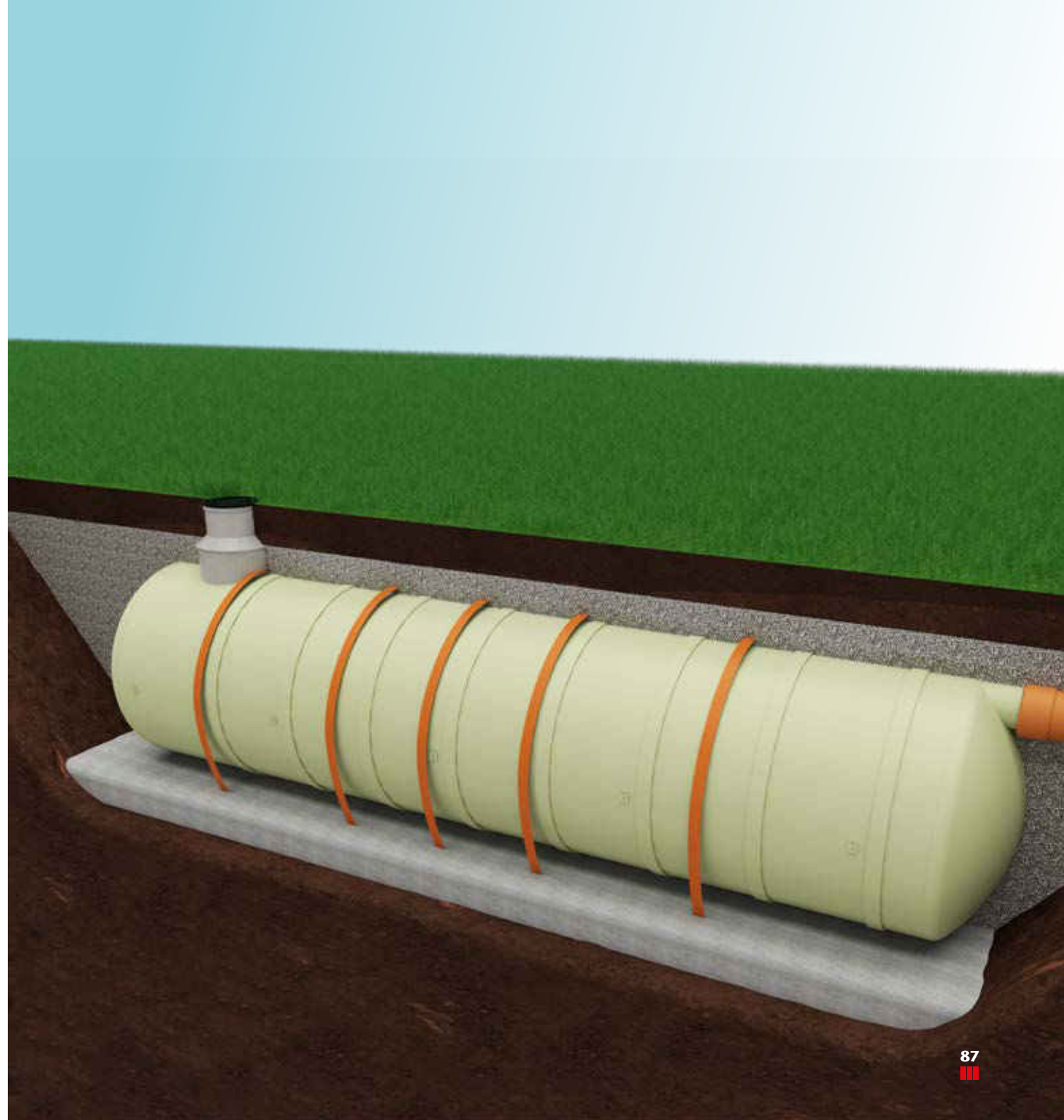



ACO Reference projects:

Tunnels



Tunnel Šarani E-763, Serbia

Investor:
Koridori Srbije

ACO Solution:

- ACO ProTunnel
- ACO Valve shaft
- ACO SecurAlarm system
- ACO Oleopator C



ACO Reference projects:
Tunnels





Tunnel Echemishka, Bulgaria

Investor:

Road Infrastructure Agency

ACO Solution:

- ACO Monoblock
- ACO Pipes
- ACO Oleopass G
- ACO Sludge trap
- ACO Shut-off shaft
- ACO Securata alarm system



ACO Reference projects:

Tunnels





HAC A1 Tunnel Grič, Plasina, Croatia

Investor:
Hrvatske Autoceste d.o.o

ACO Solution:
■ ACO Multitop



ACO Reference projects:

Tunnels



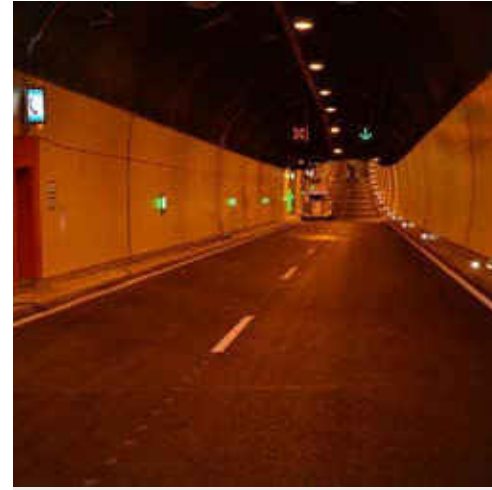

Kanaltunnel, Rendsburg Germany

Investor:

Wasser- und Schifffahrtsamt Kiel-
Holtenau

ACO Solution:

- ACO KerbDrain KD
- Access chamber
- Expansion joint element



ACO Reference projects:

Tunnels





Tunnel Köln Domhof, Germany

Investor:

Stadt Köln

ACO Solution:

- ACO Monoblock T
- ACO Multitop



ACO Reference projects:
Tunnels





Tunnel B96n, Germany

Investor:
Freistaat Sachsen

- ACO Solution:**
- ACO Monoblock T
 - Access chamber
 - Expansion joint element

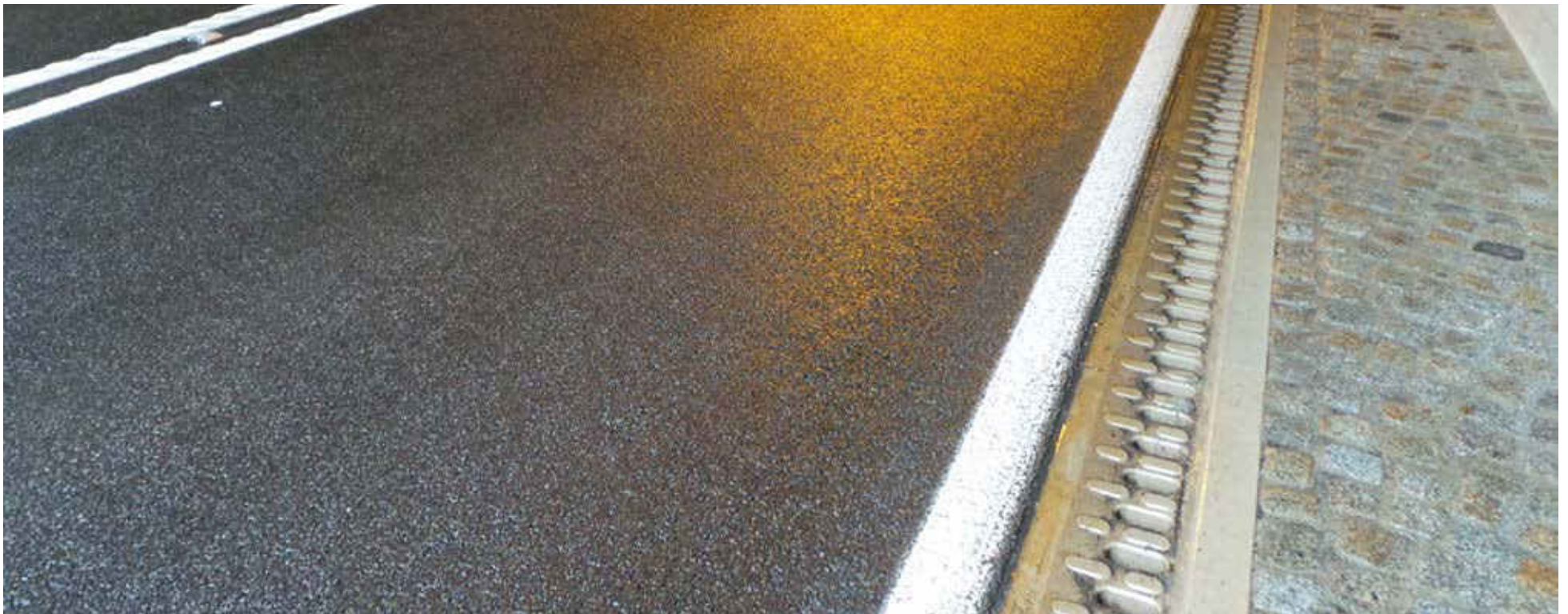

ACO Reference projects:
Tunnels





Tunnel Karaula, Bosnia and Herzegovina

Investor:
Public Company Roads

ACO Solution:
■ ACO Multitop



ACO Reference projects: Tunnels



Tunnel Vitinya, Bulgaria

Investor:
Road Infrastructure Agency

- ACO Solution:**
- ACO Monoblock
 - ACO Pipes





Tunnel Preseka, North Macedonia

Investor:
Public Enterprise for State Roads

ACO Solution:

- ACO ProTunnel
- ACO Oleopator
- ACO Shutt-off shaft
- ACO GRP Tank



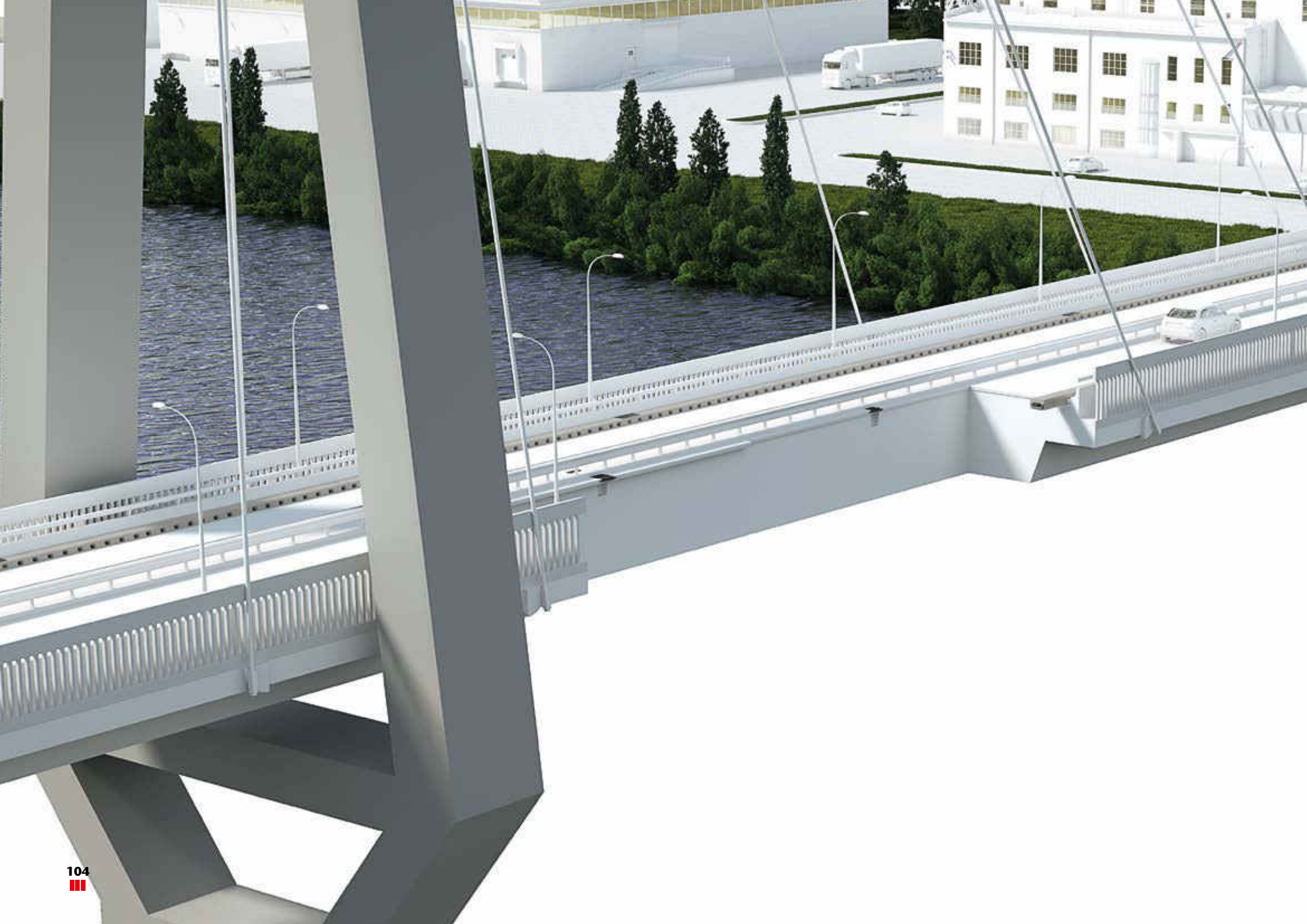

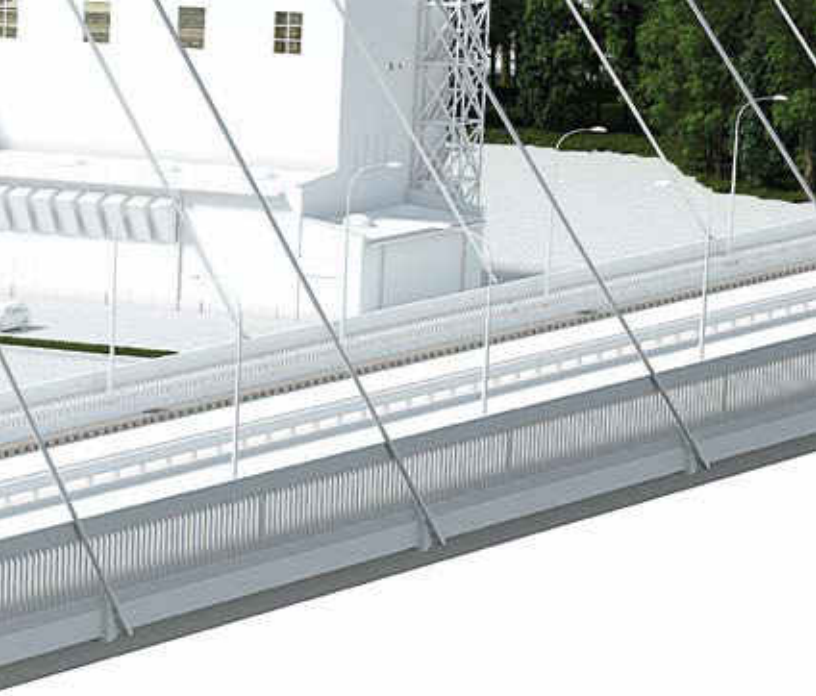

ACO Solutions for Bridges

In the case of bridge structures, there are high requirements to the specifications due to the high risks of movement and the need to protect the expensive infrastructure. ACO offers solutions for drainage of bridges and rainwater management in accordance with the highest requirements of European standards and local regulations for road facilities.

Challenges for the design, construction and maintenance of bridges

1

Watertight installation

If the connection between the gully and the waterproofing is compromised this might lead to leakages and corrosion which will damage the structure of the bridge and cause expensive repairs.



2

Draining the water

Surface waters must be drained from the road via a pipe collector system. This prevents the water from pouring over the structural columns of the bridge and damaging them.



3

Spillage of dangerous substances

When dangerous substances are spilled they end up in the collector system and from there into the soil and the water bodies at the base of the bridge. This leads to the pollution of groundwater and is a direct risk to the environment.



European norms and regulations



Guidelines for application and technical documentation for drains of road bridge facilities, Ministry of Regional Development and Public Works, 1997

4.1. Drains are placed next to the curb of the roadway of the facility. In cases where this is not possible due to the presence of a main beam of the superstructure, the drains can be moved to the sidewalk, and the direction of the water to the drain is carried out with oblique execution of the curb from a distance of not less than 1.00 m.

4.2. In the case of bridge structures with a bilateral transverse slope of the roadway (straight section of the road), the drains are provided on both sides of the traffic lane.

4.3. In the case of facilities with a one-sided transverse slope of the roadway (curved road sections and motorways), drains are provided on one lower side of the traffic lane.

ACO System solution

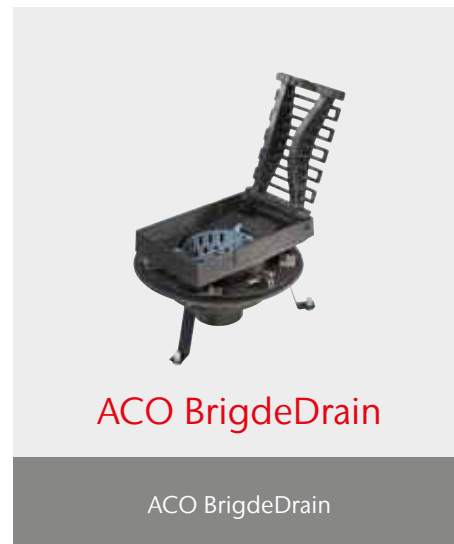





Bridges

ACO KerbDrain KD 200

Combined kerb and drainage system for bridges

ACO KerbDrain KD200 is a low profile kerb system with integrated drainage, especially designed for draining of bridges. The solution offers a number of benefits - the surface drainage is taken away from the road and there're no interruptions in the pavement. The high hydraulic capacity of the system guarantees effective collection and drainage of the surface waters. The system elements are manufactured from polymer concrete which is resistant to atmospheric and chemical influences. The system is suitable for a variety of bridge structures.

ACO KerbDrain KD 200

Advantages of the system

- Shallow depth combined kerb drainage system with high durability
- Intelligent solution for optimizing the cost of construction
- One piece elements without separate parts
- A range of product accessories for fast and easy installation
- CE marked according to BDS EN 1433: 2002, load class D400

Watertight connection channel

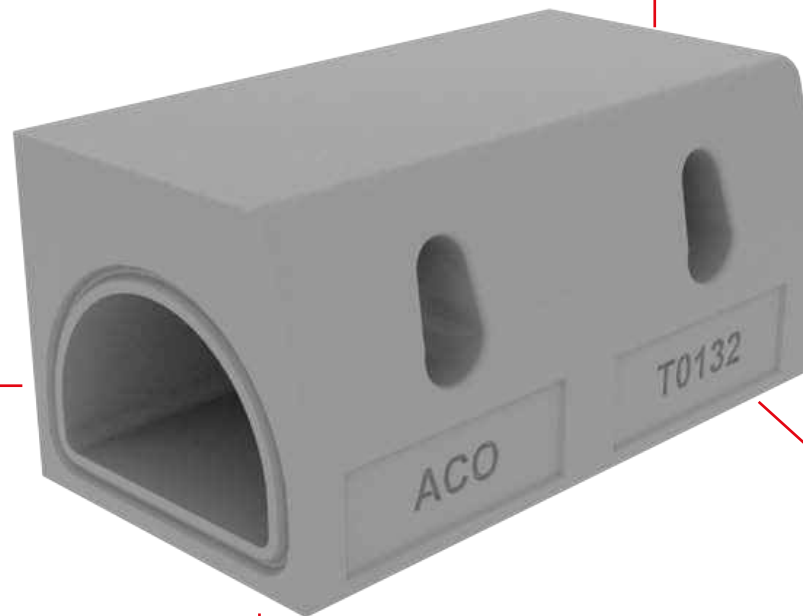

50% higher durability than conventional kerbs

The openings are designed to prevent large waste to enter the channel

Thermally and chemical resistant, manufactured from recycled and recyclable materials



Low installation height



End plate



Inspection element



Element without openings

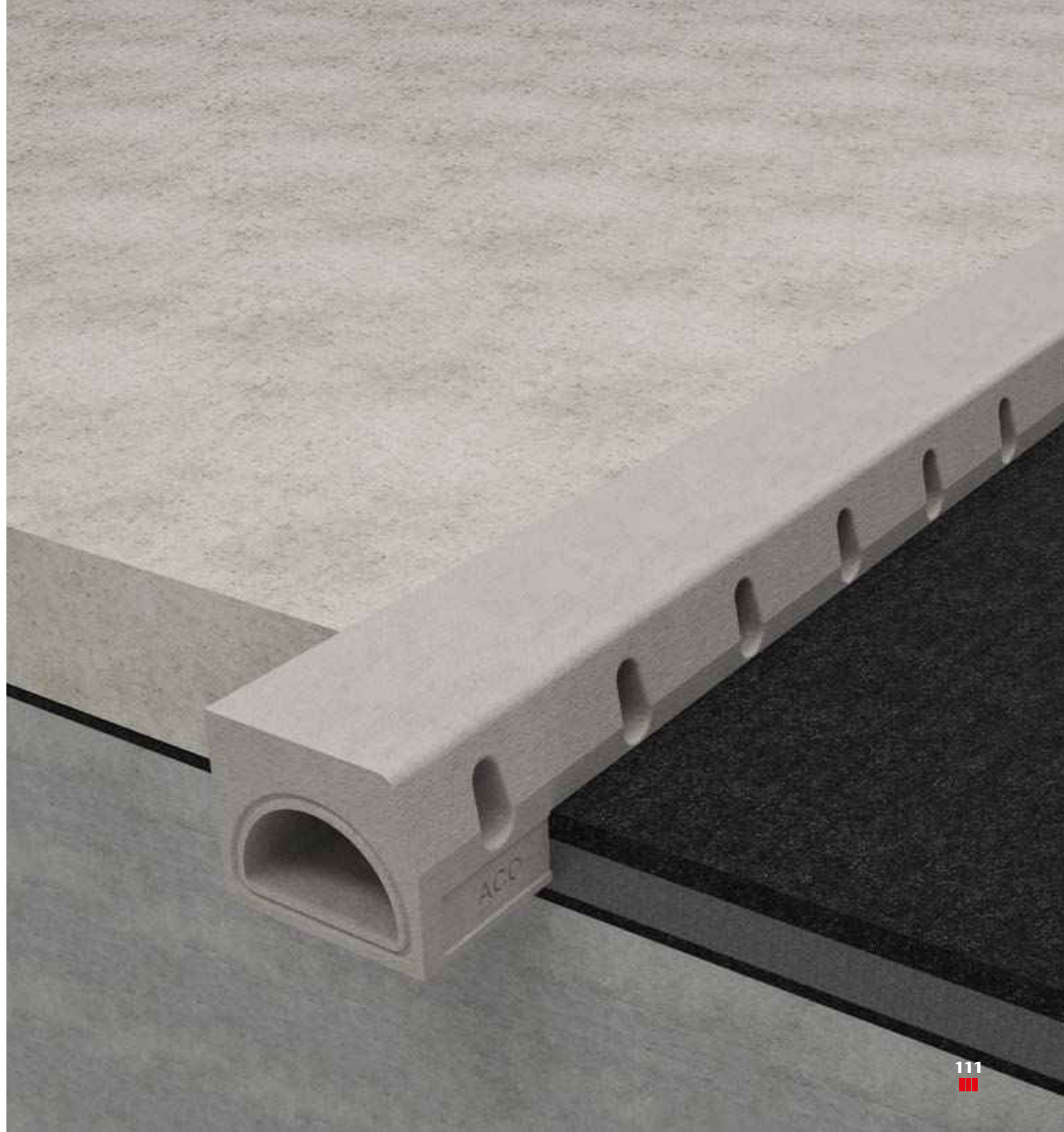





Bridges

ACO BridgeDrain

Cast iron bridge gully

When it comes to bridge drainage, the main objective is to effectively drain the water from the surface in order to avoid aquaplaning or ice on the road, as well as to protect the bridge structure from the atmospheric influences. The ACO Multitop rainwater cast iron gullies guarantee optimal durability, high hydraulic capacity and reliable connection with the waterproofing of the bridge foundation.

ACO BrigdeDrain

Advantages of the system

- Manufactured from cast iron for durability
- Load class D400 according to BDS EN 124
- With high hydraulic capacity
- With bolt locking to prevent accidents
- With rubber sealing to prevent wear and tear
- With the option for lateral (sideways) water intake during construction
- Reliable connection with the waterproofing

Possibility to control the height of the upper part, side adjustment through sliding and rotation



Stainless steel boltless locking

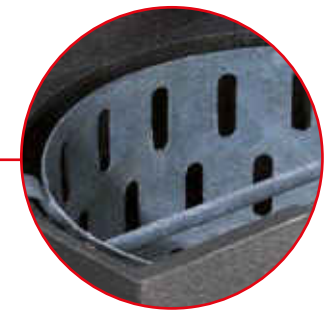

Silt basket from galvanized steel



Easy and fast opening and closing



Flange for connection with the waterproofing

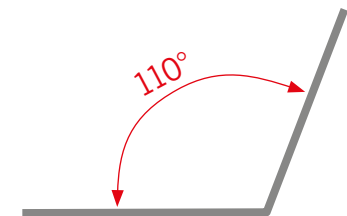

Guaranteed stability of the system when the grating is open through a wide opening angle

300x500 Grating



with vertical discharge



with horizontal discharge

500x500 Grating



with vertical discharge



with horizontal discharge





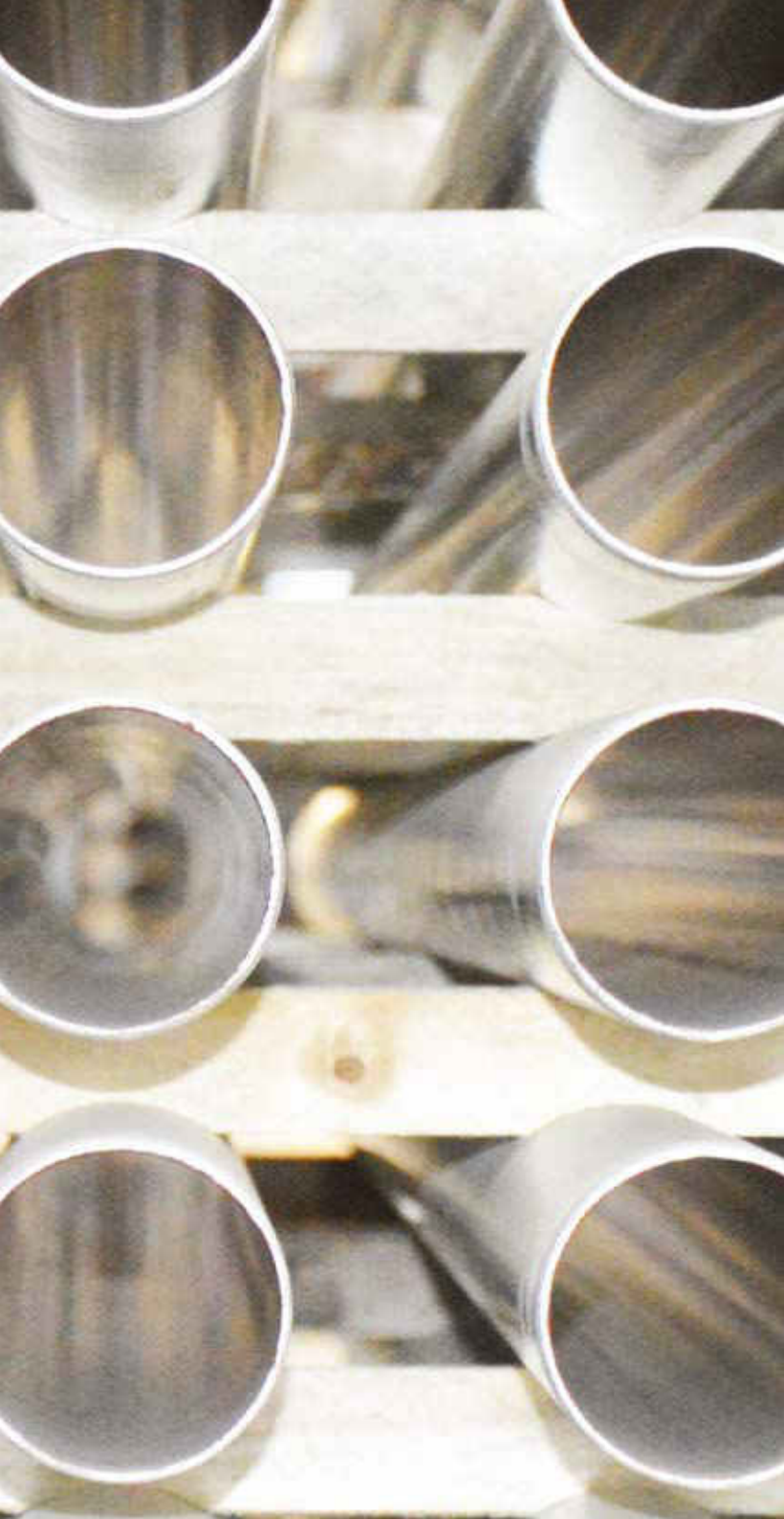

Bridges

ACO Pipe

Drain pipes from stainless or galvanized steel

The drainage of water from a bridge needs to be done in a way that protects the bridge structure and guarantees that the water will be safely transported to oil and heavy metal separators. The stainless steel or galvanized steel pipes offer a complete system of elements with guaranteed durability and the necessary chemical resistance.

ACO Pipe

Advantages of the system

- Manufactured from galvanized or stainless steel for durability
- With socket connection for fast installation
- System solution with a wide range of elements
- Low weight
- High chemical resistance

Resistant to changing atmospheric conditions



Optimal resistance against chemical substances



Integrated rubber sealing



Socket connection

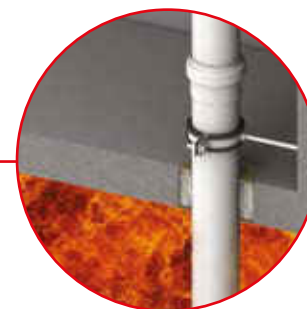

Fire safety protection corresponding to the highest class A1, non-flammable material



Bends



Single branches



Single branches



„P“ trap

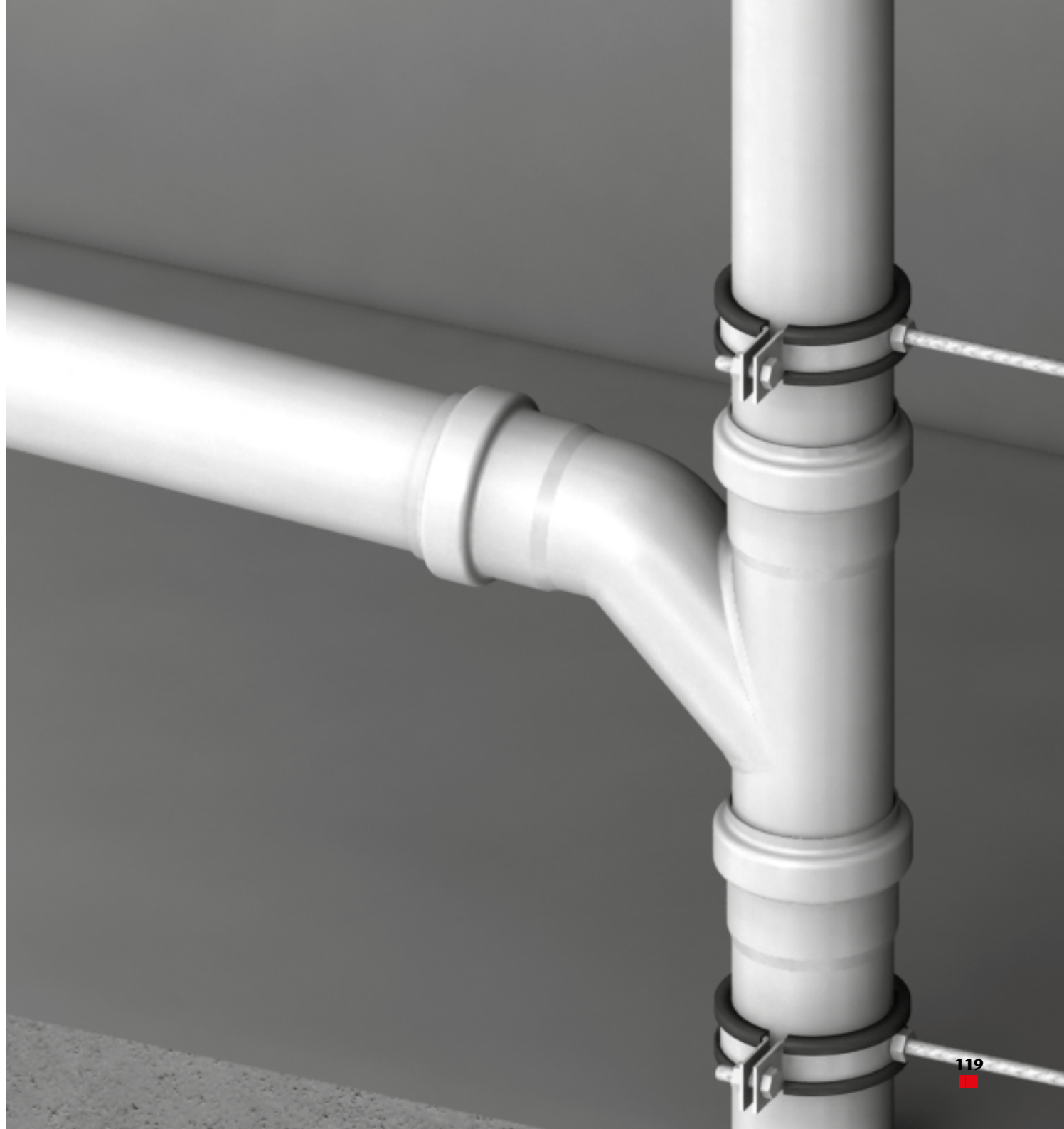

ACO Reference projects:

Bridges





Bridge Hemus Highway, Bulgaria

Investor:
Road Infrastructure Agency

ACO Solution:

- ACO BridgeDrain
- ACO Pipes



ACO Reference projects:

Bridges





Trakia Highway Bridge, Bulgaria

Investor:
Road Infrastructure Agency

ACO Solution:

- ACO BridgeDrain
- ACO Pipes



ACO Reference projects:
Bridges





Struma Highway Bridge, Bulgaria

Investor:
Road Infrastructure Agency

ACO Solution:

- ACO BridgeDrain
- ACO Pipes



ACO Reference projects:

Bridges





Bridge Čiovo, Croatia

Investor:
Hrvatske ceste d.o.o

- ACO Solution:**
- ACO BridgeDrain
 - ACO Multitop Bituplan



ACO Reference projects:

Bridges





**Viaduct Ravbar Komanda,
Slovenia**

Investor:
DARS d.d.

ACO Solution:

- ACO Monoblock RD



ACO Reference projects:

Bridges





Bridge Zemun-Borča Serbia

Investor:
Grad Beograd

ACO Solution:

■ ACO BridgeDrain

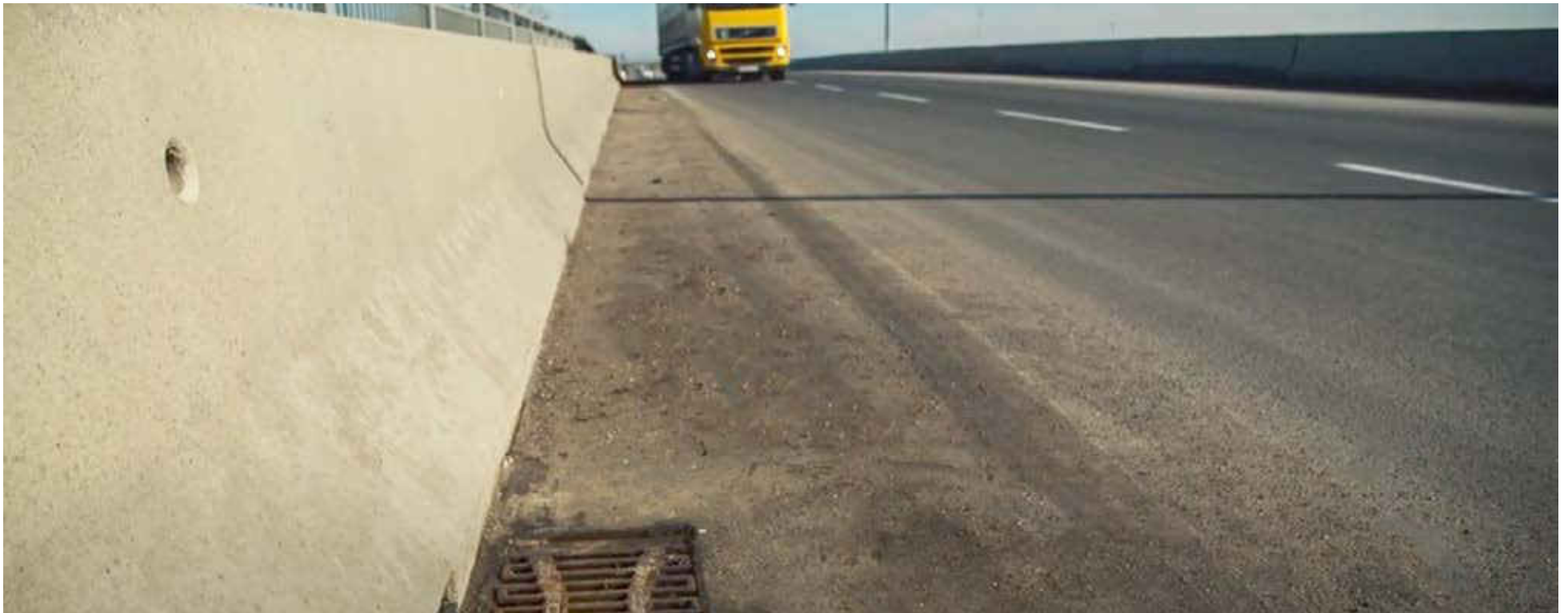

ACO Reference projects:

Bridges





Zhuhai-Macao Bridge, Hong Kong

Investor:
Hong Kong-Zhuhai-Macao
Bridge Authority

ACO Solution:

- ACO Monoblock





ACO Reference projects:

Bridges





Köhlbrand bridge, Hamburg, Germany

Investor:
Hamburg Port Authority

ACO Solution:

- ACO BridgeDrain



ACO Reference projects: Bridges



Brčko Bypass Road, Bosna & Herzegovina

Investor:

Public Company Brčko Roads

ACO Solution:

- ACO BridgeDrain
- ACO Oleopator Bypass
- ACO KerbDrain Bridge





Autobahn BAB A1, Bad Schwartau, Germany

Investor:
LBV SH

ACO Solution:

- ACO KerbDrain Bridge



ACO Reference projects:

Bridges



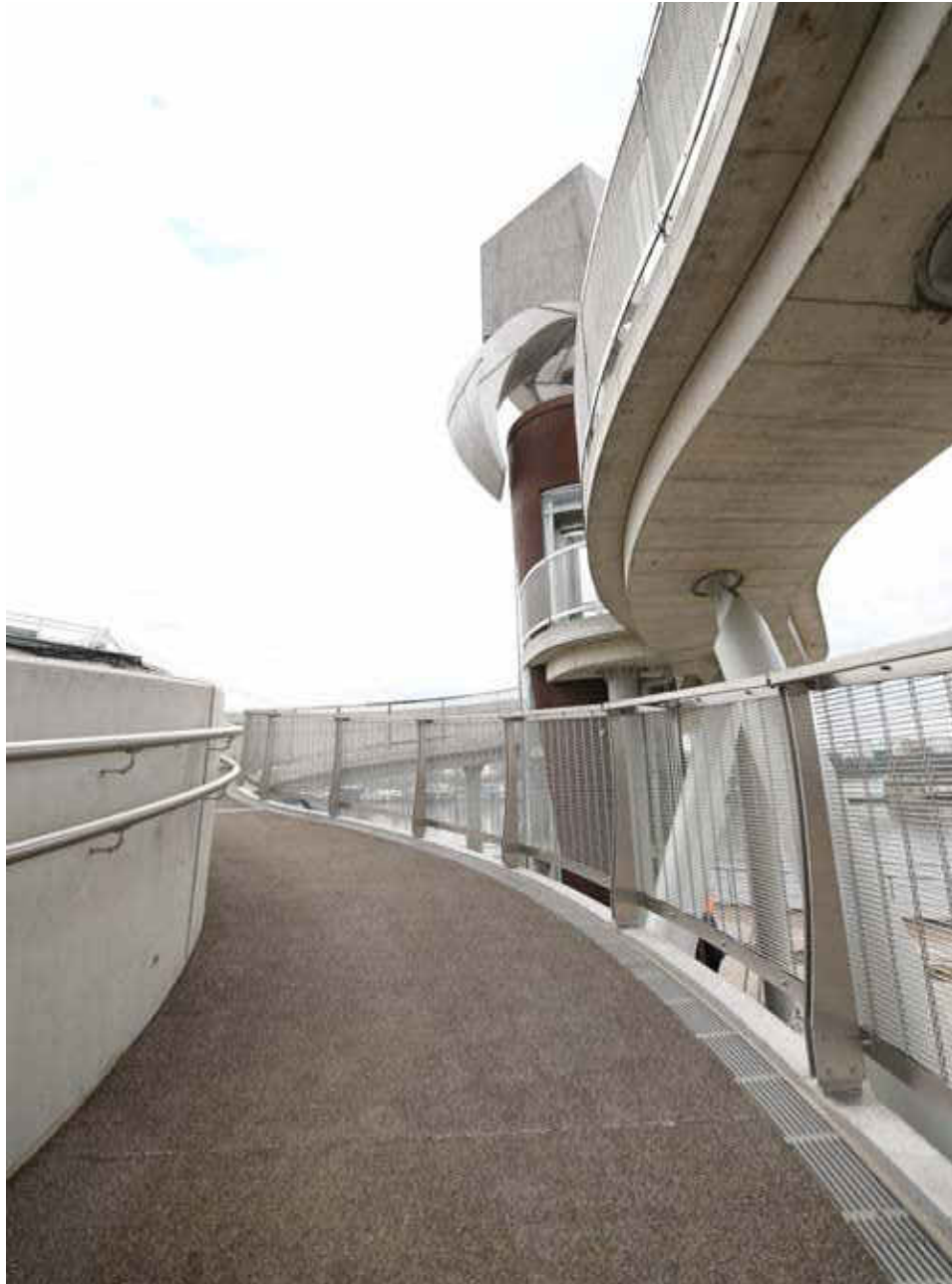

Pedestrian bridge Kalemegdan fortress in Belgrade, Serbia

Investor:

Grad Beograd

ACO Solution:

- ACO Bespoke stainless channels
- ACO SlotDrain
- ACO Uniface covers
- ACO Monoblock



4





ACO Solutions for Roads

Design, construction and maintenance of transit roads meet the challenges of even surface, drainage with small slope of the road and protection of crossing amphibians. ACO offers complex solutions for those challenges by providing effective drainage, comfort and safety on the road.

Challenges for the design, construction and maintenance of transit roads

1

Amphibian protection

When roads cross the habitat of reptiles and small animals this may lead to disturbing their natural paths and is dangerous to their survival.



2

Flat surface and protection against sinking

Damage to the road surface around gullies and manhole covers can pose a risk to vehicles and passenger safety.



3

Drainage for roads with small slope

Effective drainage prevents the risk of the vehicle veering out of the curve of the road due to loss of traction.



European norms and regulations



ORDINANCE No. RD-02-20-8 of 17 May 2013 for the design, construction and operation of sewerage systems

Art. 26. (1) Revision inlets manholes designed under streets are provide with covers with an upper surface at the level of the street pavement and meet the following requirements:

1. correspond to the load class on the street;
2. ensure road safety and are insured against vandalism;
3. are insured against failure.

Art. 28. (1) The rain receiving facilities are provided in the following places:
3. across the streets at a slope above 8%, the grilles being provided with a system against accidental opening or being a monolithic integral part of the body.

Art. 40. (1) In order to reduce the hydraulic load of the sewerage systems and in order to balance the outflow of the waste waters to the WWTP the possibility for retention and discharge of unpolluted surface runoff rain waters in infiltration drainage systems near the zone of their formation or direct taking them to a surface water body.

ACO System solution



ACO Klimatunnel

Protective tunnels for amphibians



ACO KerbDrain

ACO KerbDrain *see page 24



ACO Combipoint

Point drainage



**ACO Multitop
Bituplan**

Self levelling manhole covers





Roads

ACO Klimatunnel

Tunnels for protection of amphibians

Many amphibian species undertake seasonal migration between land habitats and their spawning grounds in the water. The connection of the natural areas inhabited by animals is carried out with specially designed elements.

Protective structures for animals are a safe and effective measure for biodiversity. In addition, they also contribute to road safety and prevent potential accidents when amphibians are crossing the carriageway.

ACO Klimatunnel

Advantages of the system

- Manufactured from polymer concrete for durability
- System solution with a range of options
- Load class D400 according to BDS EN1433
- Monolithic system that guarantees stability



Solid top tunnel



Slotted top tunnel



Plate for tunnel floor



Guide wall panel



Tunnel entrance









Roads

ACO Combipoint

Cast iron gullies with high hydraulic capacity

The ACO Combipoint PP system is the first one that can be rotated, stretched or shortened telescopically, be installed at an angle and at the same time offer a number of advantages for design, installation and operation. ACO Combipoint also offers a number of advantages for point drainage. Its intelligent structure distributes the load over the surface of the road carriageway. The grating remains at the same level as the level of the asphalt. The system is developed for load class up to D400, according to the European Norm 124:2003.

The product has passed tests for quality, durability and safety, for which it has been marked in accordance with the standard. It also comes with an option for secret bolt locking.

ACO Combipoint

Advantages of the system

- Flat surface - the system distributes the dynamic loads
- Total adaptation of the gully body
- Fast and easy installation due to its low weight
- Secret bolt locking against vandalism
- Load class D400, according to BDS EN 124:2003
- Hydraulic capacity of 19,5l/s



Secret bolt locking against vandalism



Double hinge for opening



Easy opening due to the low weight of the grating - 28.5kg



Minimum danger of blockage due to the optimized width of the openings



Boltless locking



Load distribution system



Bottom part with opening



Bottom part



Cone



Upper part



Upper part with opening







Roads

ACO Multitop Bituplan

Self levelling manhole covers

The innovative ACO Multitop system is developed to comply with the modern challenges of the road infrastructure. The intelligent structure of the components allows the distribution of the dynamic load from the traffic, which guarantees that the cover remains at the same level as the road surface. The flat surface of the installation guarantees safety and comfort for vehicles and passengers.

ACO Multitop Bituplan

Advantages of the system

- Class D400 according to BDS EN 124
- Watertight system with integrated sealing resistant to oils and fuels
- Three special locking devices
- Spheroidal graphite cast iron (GJS) for many years of operation

Load class D400 according to the requirements of BDS EN 124:2003

Soundproofing pad from highly resistant PEWEPREN

Secret bolt locking against vandalism

Easy installation due to the light weight of the cover and its intelligent structure

Component for easy and safe access for inspection

Special anti slip surface, regardless of the direction of traffic

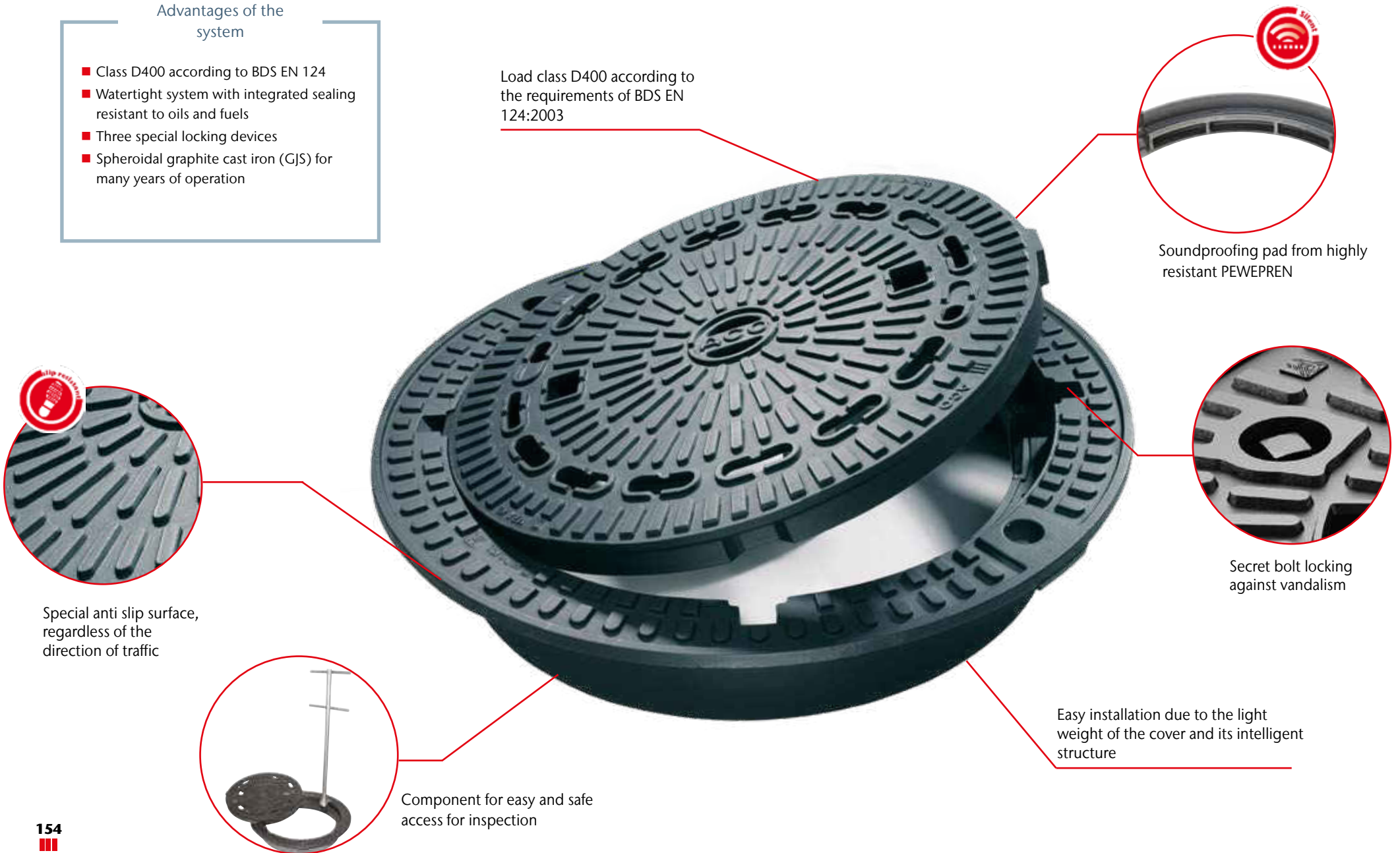



Spheroidal graphite cast iron (GJS) cover



Cast iron ring (EN GJL)



Key for opening the bolt connection



Levelling wedges for installation



ACO Reference projects:
Roads





Ring Road Sofia, Bulgaria

Investor:

Road Infrastructure Agency

ACO Solution:

- ACO Monoblock
- ACO Bridge Drain
- ACO KerbDrain
- ACO Multitop Bituplan



ACO Reference projects:

Roads





Ring road Burgas, Bulgaria

Investor:
Road Infrastructure Agency

ACO Solution:

- ACO Monoblock
- ACO Multitop Bituplan
- ACO Combipoint



ACO Reference projects:

Roads

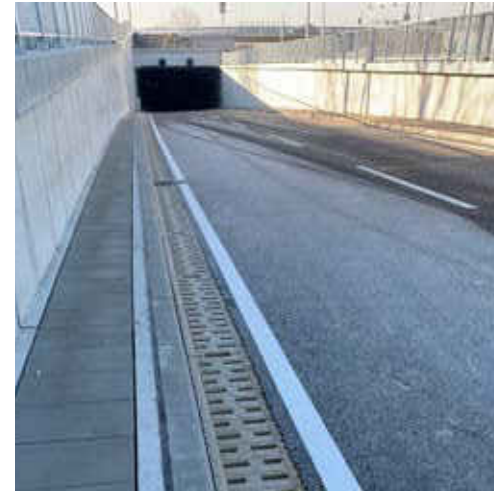
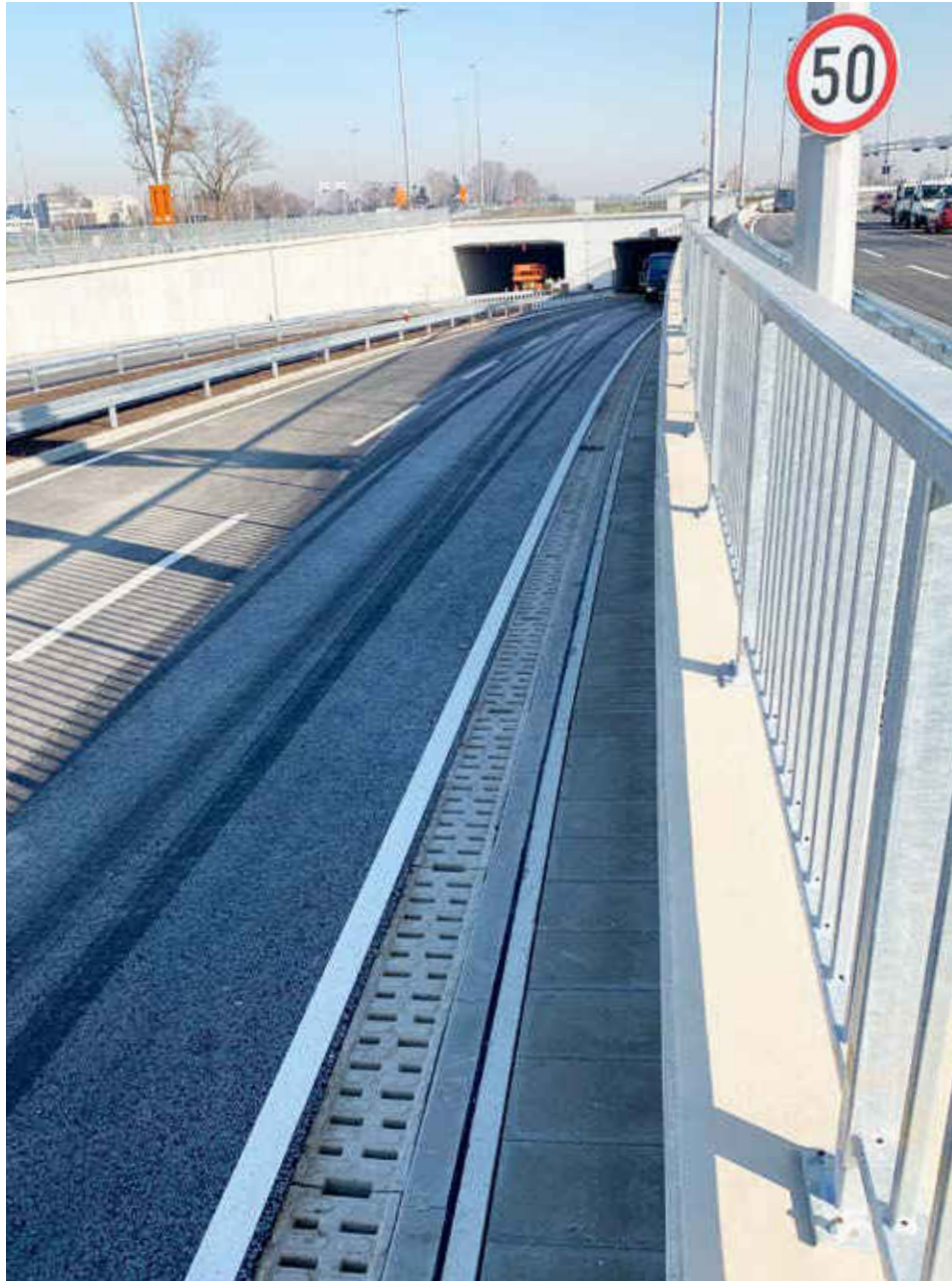

Roundabout, Zagreb, Croatia

Investor:
Grad Zagreb

ACO Solution:

- ACO Monoblock
- ACO KerbDrain
- ACO Combipoint



ACO Reference projects:

Roads





Underpass, Poljcane, Croatia

Investor:

DRSI

ACO Solution:

- ACO Multiline
- ACO KerbDrain
- ACO Oleopass P

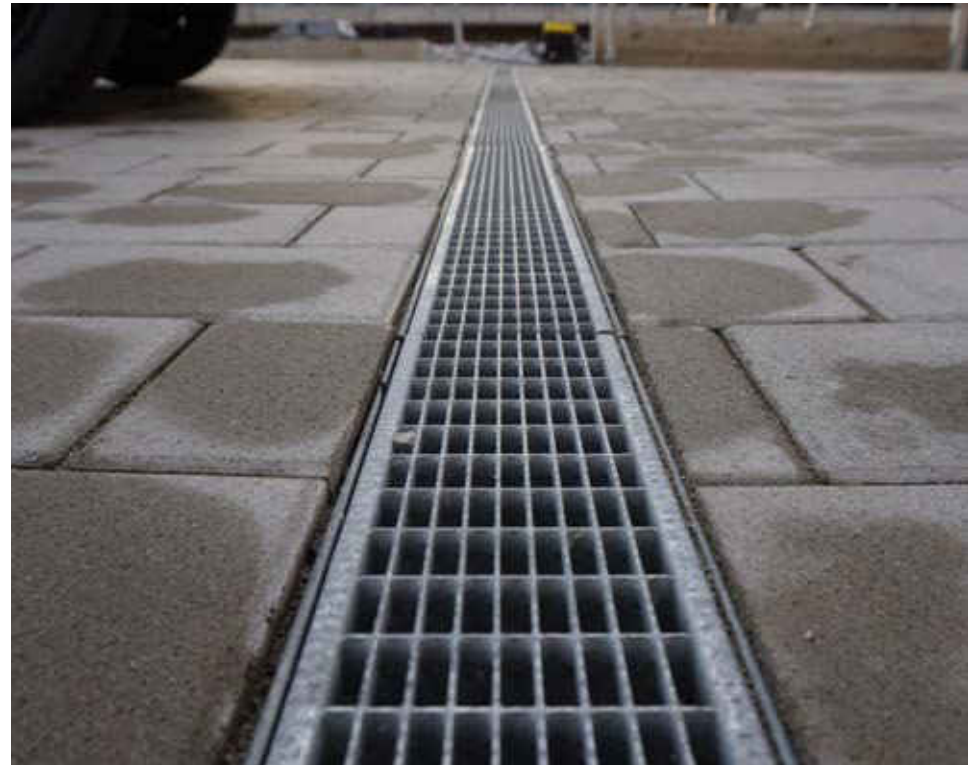



ACO Reference projects:

Roads



Ring Road, Ljubljana, Slovenia

Investor: DARS d.d.

ACO Solution:

- ACO Monoblock RD



ACO Reference projects:

Roads





Road Radomlje - Rova, Slovenia

Investor:
Občina Domžale

ACO Solution:

- ACO Klimatunnel



ACO Reference projects:

Roads





Landstrasse L28, Germany

Investor:
Niedersächsische Landesbehörde für
Straßenbau und Verkehr

ACO Solution:

■ ACO KerbDrain



ACO Reference projects:

Roads





Kreistverkehr - Tulln, Austria

Investor:
Stadtgemeinde Tulln

ACO Solution:

- ACO KerbDrain



ACO Reference projects:

Roads





Umfahrung Laa an der Thaya, Austria

Investor:

ACO Solution:

- ACO KerbDrain



International partnerships and awards:

ACO shares its many years of practical experience through expert participation in a number of industry and professional organizations and associations.



CEN European Committee for Standardization



British Water, UK



Deutsches Institut für Normung



IWA International Water Association



Chartered Institute of Highways, UK



Queens Awards for Enterprise Innovation



Road Safety Institute



Any questions?

askACO

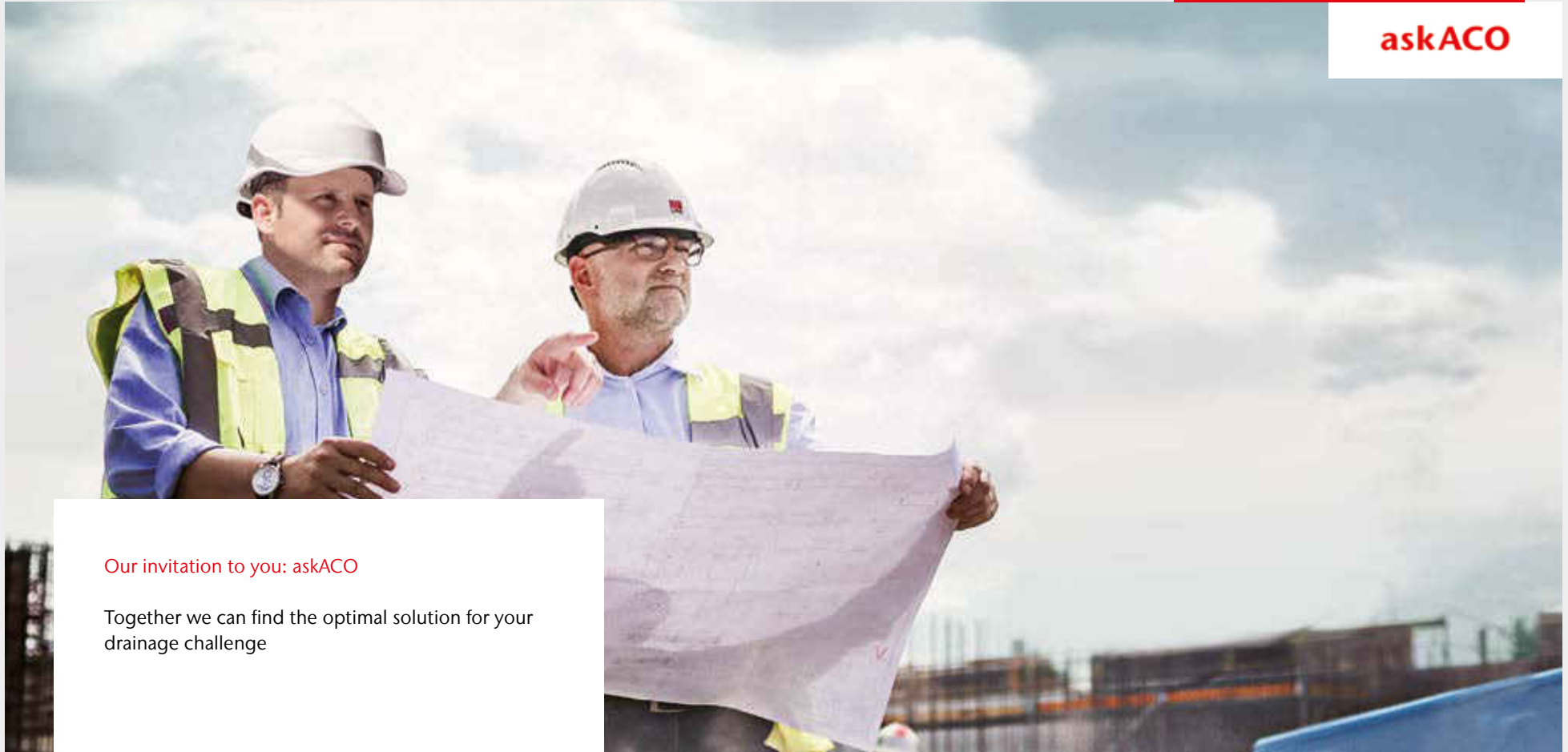

Our invitation to you: askACO

Together we can find the optimal solution for your drainage challenge

ACO Online

You will find all important information on the ACO web page. Here you can access technical documentation, product information, specification texts and installation details, necessary during design.

www.aco.com

Find local websites and contacts

Welcome to ACO Academy!

ACO Academy offers not only practical information but also focus on future trends and opportunities. The annual agenda of ACO Academy includes variety of events for experts in construction business that gather power for the infrastructure of tomorrow.