

Commercial Kitchen Guide
for Drainage, Grease & Organic Waste Management

Hygiene**First**

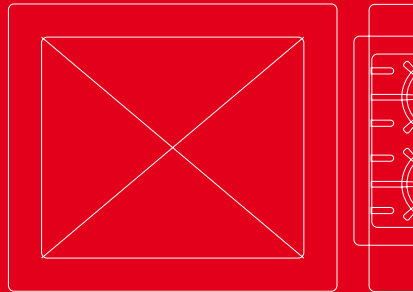

Commercial Kitchen Guide
for Drainage, Grease & Organic Waste Management

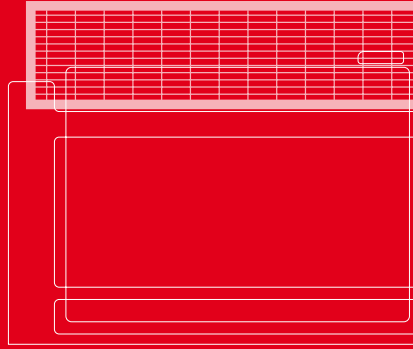

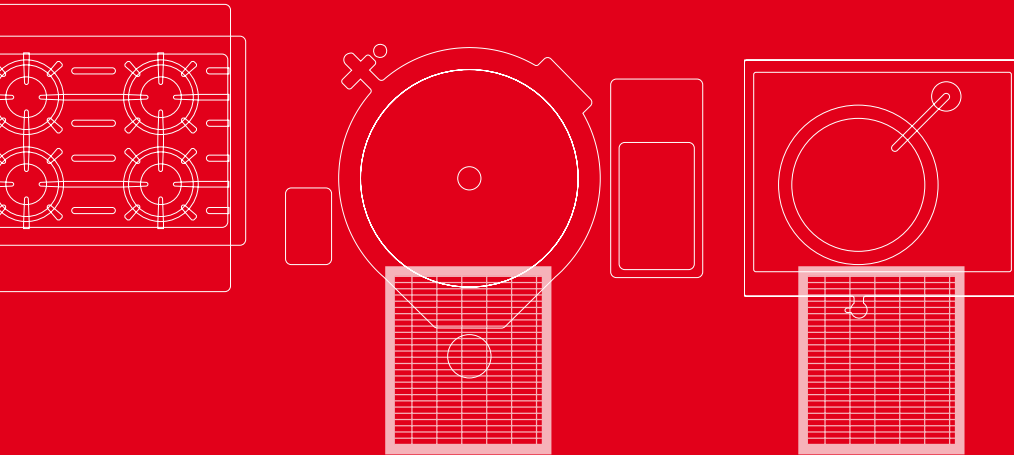
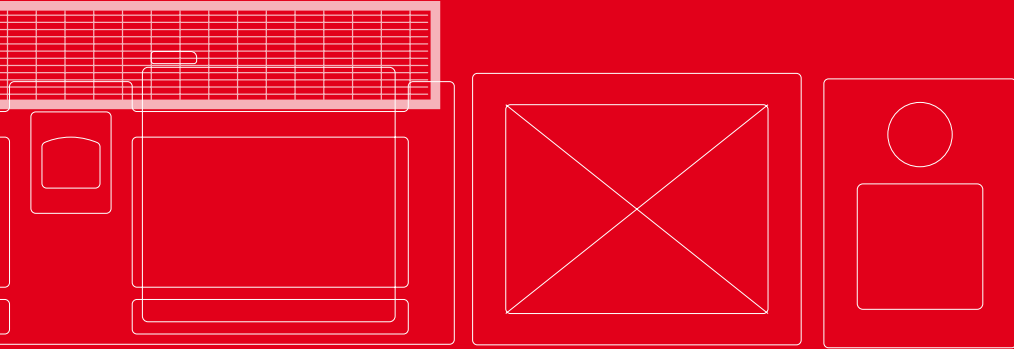





Contents

- 1. Introduction**
- 2. Commercial kitchens**
- 3. Drainage, Grease and Waste management**
- 4. Material properties**
- 5. Fire protective solution**
- 6. Cleaning and maintenance**
- 7. Kitchen layouts**



THE HYGIENIC PERFORMANCE
THROUGHOUT THE WHOLE
PRODUCT LIFE SPAN



1. Introduction

1.1. The ACO group

1.2. HygieneFirst

1.3. ACO and Commercial kitchens

1.1. The ACO group

Who we are

ACO is the established leader in providing drainage systems for the food service industry. Commercial Kitchen drainage system is designed to provide maximum reliability, longevity, and durability while preventing hygienic issues that can put your facility at risk. More than 60 years of drainage experience makes ACO the world-class supplier of drainage systems.

What we do

ACO drainage and waste disposal systems are designed around the three most important topics for food service industry: food safety, cost management, and health & safety. We designed our products to drain processed wastewater hygienically and economically, exceeding the high standards established by the European Hygienic Engineering and Design Group (EHEDG).

Where we are

With sales offices throughout the world and 30 modern production sites situated throughout Europe and the USA, we are fully conversant with international standards and also work extensively with key industry bodies to stay ahead of the curve when it comes to creating the most modern systems available.

Why choose us

We work hand-in-hand with commercial kitchen specialists and designers to create systems suited specifically to their needs. When using ACO drainage systems you can expect optimal top performance, design with emphasis on hygienic performance, and the highest level of confidence that you are using the best drainage system on the market.





ACO at a glance

- 1946, company founded by Josef-Severin Ahlmann
- 3.900 staff in more than 40 countries (Europe, North and South America)
- 30 production sites in 15 countries
- Sales 2014: 670 million €

Global development in sales in million Euro

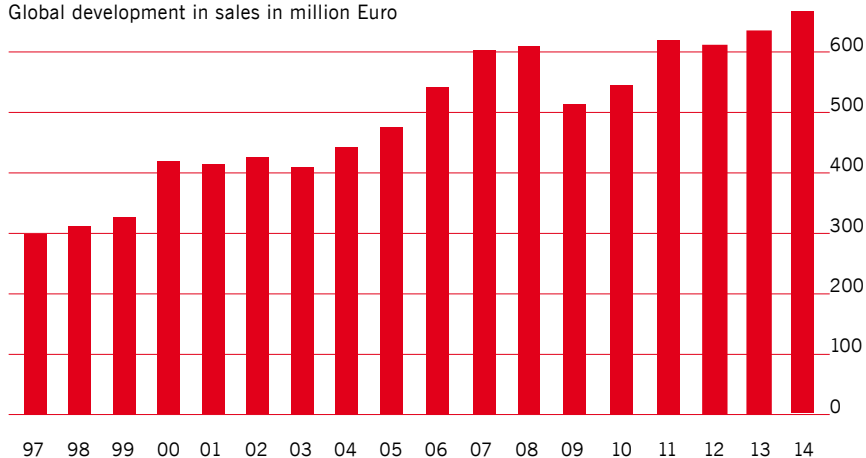



COMMITMENT TO ULTIMATE
HYGIENIC PERFORMANCE



1.2. HygieneFirst

As one of the world's leading commercial drainage specialists, ACO Group understands the critical role that drainage plays in a successful commercial food preparation business. We appreciate that food safety, hygiene and cost control are all vital factors yet we also understand that for many, drainage is out of sight and therefore out of mind.

As a result, many drainage systems are not designed well. At best this leads to costly on going cleaning and maintenance, and at worst it can result in food contamination, closure of a facility and the loss – or even closure – of business. As the company that's driving the future of drainage, we are determined to change this by raising the profile of hygienic drainage and improving standards across every part of the process.

Our HygieneFirst philosophy represents our commitment to delivering products that provide ultimate hygienic performance. We design intelligent drainage solutions that minimize operational costs without compromising food safety.

Hygiene**First**

1.3. ACO and Commercial kitchens

Commercial kitchens are extremely busy environments with potentially wet and greasy floors due to the abundance of liquids used in both the cooking and cleaning processes, and of course, the high temperatures of these liquids. Waste water can also contain fat which is a major cause of pipe blockages and cannot be released to the waste water system. In combination, these factors may affect Food Safety, Health & Safety and Operational cost.

Food safety

Food safety can be severely affected due to poor drainage, grease and waste systems. ACO solutions are designed to effectively and safely drain away and handle process water. We design our products specifically to reduce the risk of food contamination.

Cost control

Management of costs is a major factor in business today. Commercial kitchen equipment including drainage, grease and waste disposal systems should fulfil its function with low operational cost in mind throughout its entire lifespan. ACO drainage, grease and waste disposal systems are designed so they can be easily maintained, reducing associated cleaning costs and maximising hygienic performance.

Health & safety

Minimizing the risk of injury in the workplace is of prime importance to any commercial kitchen facility. It's essential that your facility has a drainage system which improves health and safety conditions during cleaning, emptying and operation, while ensuring hygiene is always front of mind.





OUR AIM IS TO REDUCE
THE RISK OF FOOD CONTAMINATION





PROFESSIONAL DRAINAGE
FOR HOT AND BUSY KITCHEN ENVIRONMENT



2. Commercial kitchens

2.1. Commercial kitchen introduction

2.2. Commercial kitchen areas

2.2.1. Storage and preparation area

2.2.2. Production area

2.2.3. Washing and disposal area

2.1. Commercial kitchen introduction

Efficient drainage assists in managing risk: operationally, it helps prevent accidents; hygienically, it is required by European Law - EC 852, and is embodied within the HACCP (Hazard Analysis and Critical Control Point) framework through the Prerequisite Programme (PRP). Illustrating adequate drainage design together with appropriate cleaning and maintenance procedures within the PRP is the prime objective of this guide. This process should also form part of the Design Risk Analysis for any building design.

A well-designed drainage system should have:

- A debris filter at outlet
- Easily removable and clean non slip gratings with no sharp edges for optimum employee safety
- Easily removable foul air trap
- Hygienic design to avoid bacteria build-up
- Proper volume capacity size
- A waste disposal system, such as ACO Waste-Jet for removal of food debris
- A grease separator for removal of fats and grease

2.2. Commercial kitchen areas

There are three principal areas in every commercial kitchen: the storage and preparation area, the production area, and the washing and disposal area. Each area handles different processes in the commercial kitchen environment and has different demands for waste water management.

2.2.1. Storage and preparation area

2.2.1.1. Description

Storage area

The goods receiving or stores area is the main location for the receipt of all goods delivered to the catering facility including dry goods, oils, pre-packed foods, chilled & frozen foods, and even cleaning products and chemicals. The location of this area will be close to the rear of the building or service yard to accommodate the delivery vehicles and palletised loads. Care should be taken to specify **load class for gully or channel** - see Drainage guide section for details on page 54.

Food storage areas will require occasional clean down as part of either a planned cleaning program or in the case of spillage. In most circumstances capacity of the floor drain need only accommodate low flows. The choice between channel and gully is dependent on the nature of the operation, and what functional attributes are required – see Drainage guide section for details on page 48.

Ideally the drainage unit will be accessible in the centre of an area or in entrance ways as a barrier. They should not be under immobile equipment enabling easy cleaning and maintenance of the drain itself. Gratings should be removable, but also allow mobile racks and goods trolleys to travel easily over the system without risk of grating displacement.

Where Cold Storage rooms are used (coldrooms) local drainage is required for the evaporator condensate water to be discharged. The ideal solution is an adjacent drainage gully complete with a tundish to prevent splashes and provide an air break to the main drainage.

Preparation area

The preparation of food involves washing, paring or peeling, cutting, trimming or shaping and can be carried out in up to three separate areas:

- **Vegetable preparation area:** where fresh vegetables are received, stored and prepared prior to being forward to the production area.
- **Meat/Fish preparation area:** will be closest to the cooking equipment where all meat and fish can be prepared and limit cross contamination
- **General preparation areas:** will be where all other food items will be prepared and again will work closely with the production area

All these operations produce food debris and will use water either in automated machinery or manually via a sink. Within the vegetable preparation area mobile sinks can be used to transport the prepared goods to the cooking areas.

The drainage layout should ensure efficient surface water removal from within these areas using centrally located box channels, with simple one way floor gradients.

The box channel's narrow section may also aid staff safety and comfort as it is less likely to be stood on whilst ensuring they will be easy to clean and maintain.

Dependent upon the size of the operation slot or box channel's may be required at entrance way thresholds to prevent the transfer of water to corridors and other areas, thus reducing the risk of slips & falls.

2.2.1.2. Appliances

Coldrooms

A Coldroom is a pre-fabricated unit/room which stores food that requires refrigeration or freezing to maintain the product at the required temperature. The walk in coldroom or freezer will be constructed from 75mm – 100mm thick modular panels. Each panel will have an insulation material foamed between two sheets of metal.

Coldrooms or freezers are specified with either local or remote refrigeration systems (compressors).

Local refrigeration units are normally located on the ceiling of the room with remote systems located at varying distances away from the room. Inside the room itself, normally mounted on the ceiling, will be an evaporator which will blow constant cold air around the room. The refrigeration process begins with the compressor.

Gas is compressed until it becomes very hot from the increased pressure.

This heated gas flows through the coils above the cold store, which allow excess heat to be released into the surrounding air. Then the gas cools down to the point where it becomes a liquid. This liquid is then forced through a device called an expansion valve which turns into a very cold, fast-moving mist, evaporating as it travels through the coils into the store. This will produce condensation within the evaporator and needs to be drained away.

It is normally recommended that some form of air break is used in the drainage discharge, and this is where the ACO drainage should be used with a Tundish fitted externally.

It will not be acceptable to have this point within the coldroom.



DRAINAGE PERFORMANCE
WITH NO COMPROMISE
TO HEALTH & SAFETY

2.2.1.3. Typical drainage products

ACO hygienic gully



ACO hygienic box channel



ACO pipe



2.2.1.4. Example layouts

Storage area

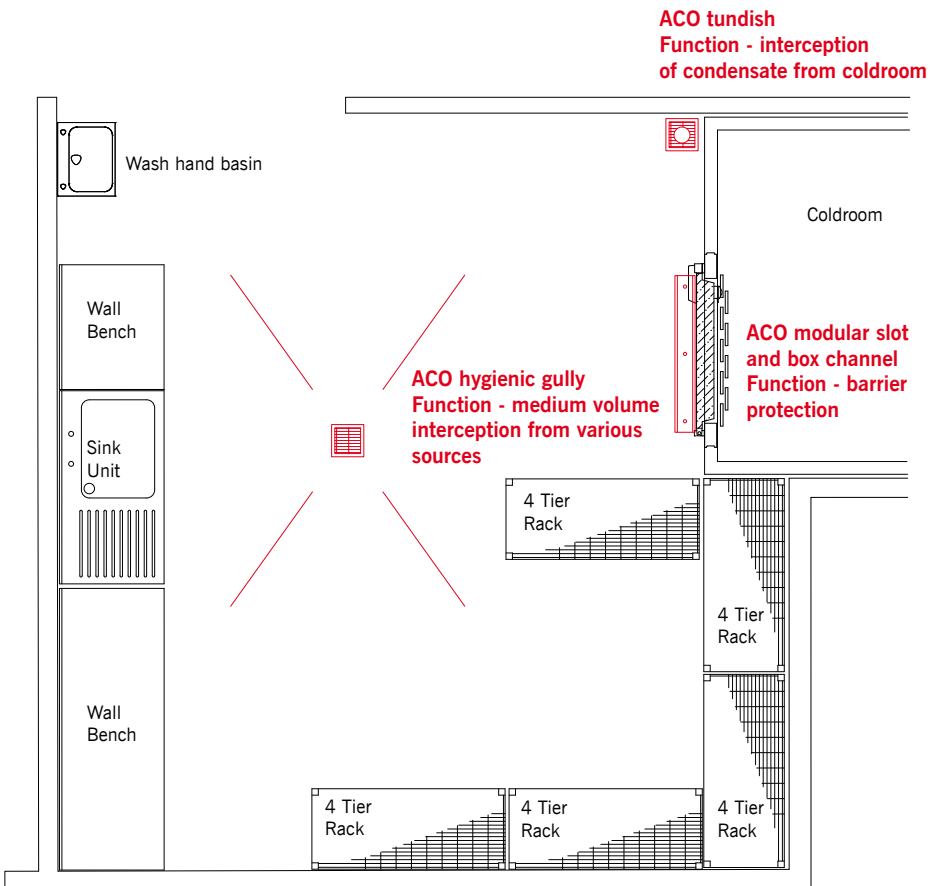

Preparation area

ACO modular slot and box channel
Function - Barrier protection to other areas

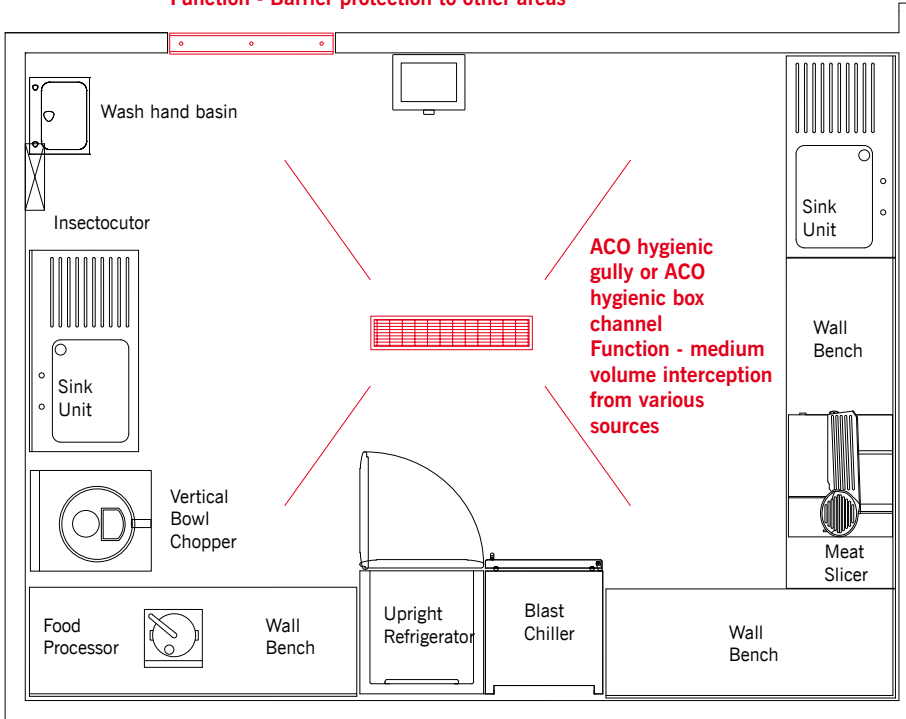

2.2.2. Production area

2.2.2.1. Description

The production area of the kitchen is the main hub of the facility and is often located at the centre of the whole catering operation. Its prime function is the cooking and finishing of food. Greasy residues may accumulate steadily on surfaces including the floor, combined with food spills this area exhibits a large potential for slips & falls.

The strategic positioning of floor drainage is crucial to facilitate cleaning and aid in the removal of water that is being produced or discharged from specialist cooking equipment such as Bratt Pans, Boiling Pans & Combination Ovens.

These appliances can also be used for the pouring of produce into containers so the sizing and positioning of hygienic box channels, tundishes or hygienic gullies for these appliances must be co-ordinated with the specialist designers or equipment manufacturers, otherwise splashing can occur causing water, grease and food debris to be spread to the surrounding floor area.

The perimeter of the main cooking area would also further benefit from the strategic location of smaller hygienic gullies or hygienic channels to facilitate the cleaning of the facility at the end of the cooking period. A smaller kitchen where production volumes are not so high may rely on the specific gullies only for this purpose.

Well designed drainage systems should have the volume capacity sized to cope with appliance discharge, debris filter at outlet, easily removable non slip gratings, and easily removable foul air trap. Ladder gratings are ideal for the high point loads that might be imposed in these areas.

2.2.2.2. Appliances

Boiling Pan

A Boiling Pan is a double-jacketed cooking vessel with an inner and outer skin. Between these two skins the medium of steam and its condensation is used to provide a constant heat over the whole area of the inner vessel. This steam is created by a steam generator powered either by Gas or Electricity. The pan would normally have a heavily insulated outer skin, and a double jacketed lid. Although named “Boiling Pan” these pieces of equipment are rarely used to boil foods, but normally to gently simmer bulk dishes such as custard, sauces, soups, or stews. Most Boiling Pans will have a fixed drain tap at the bottom of the pan, which will be a wide mouthed tap for the drawing off of wet dishes such as soups, sauces and custards. It is this drain tap that needs to be suitably catered for with an appropriately sized and specified ACO hygienic box channel to suit the volumes being discharged from this appliance.



Bratt Pan

Bratt pans are deep, rectangular cooking vessels that typically have counter-balanced pull down lid. The heat source is direct to the underside of the vessel and can be gas or electric. A Bratt Pan is able to carry out a range of cooking functions including braising, boiling, steaming, poaching, stewing, and frying. Some models have a pressurised lid so that the vessel can be used as a pressure cooking vessel. They all have a tilting feature, which depending upon the size can be operated electrically or by a hand-driven mechanism. Food product or liquids can be poured from the Bratt Pan through a “V” in the front top edge of the vessel.

It is this “V” that needs to be suitably catered for with an appropriately sized and specified ACO hygienic box channel to suit the volumes being discharged from this appliance.



Combination Ovens

The combination oven is probably one of the most versatile pieces of catering equipment any kitchen can have. A combination oven uses either a dry heat or steam injection or a combination of both to cook food in a variety of different formats. Breads, Cakes, Meat, Vegetables and Fish can all be cooked in these ovens.

Regeneration (or the reheating) of food which has been pre-cooked and chilled, can rapidly be brought up to serving temperature, making combination ovens ideal for a busy banqueting or function facility, handling both ready-plated meals and multi-portion containers.

Given the high temperatures that these ovens work at, the drainage discharge can often be in the form of stream or close to it, and therefore drainage connections should be in Copper or Stainless Steel.

It is normally recommended that some form of air break is used in the drainage discharge, and this is where the ACO drainage should be used with a Tundish fitted.

In addition to the cooking fluids and steam discharge by this appliance, at the end of each day or cooking cycle the combination oven should run through a wash or clean down cycle using cleaning products which are then discharged to the drain via the tundish.



Tilting Kettle

A Tilting kettle is most commonly used within a catering operation to prepare many different menu items, including soups, stews, gravies, puddings, sauces, pasta and rice.

A tilting kettle can also be used to braise meats, boil large quantities of water and reheat food. Most Tilting kettles consist of inner & outer stainless steel hemispheres which are welded together. Between these two hemispheres is a jacket into which steam is introduced. The steam entering the jacket condenses on the inner wall, which in turn transfers the heat to the food being cooked.

Once the food has been cooked or reheated, the product will then need to be transferred to a large trolley/pan. This will be carried out by the entire kettle body tilting forward pouring out the liquid contents. Tilting will be achieved by either a manual handle crank or an electric push button. **When the produce is poured out, this is where an ACO hygienic box channel will need to be strategically positioned to contain any spillages. The sizing and specification of this channel or gully is critical in supporting the volumes being discharged from the appliance.**



2.2.2.3. Typical drainage products

ACO hygienic box channel

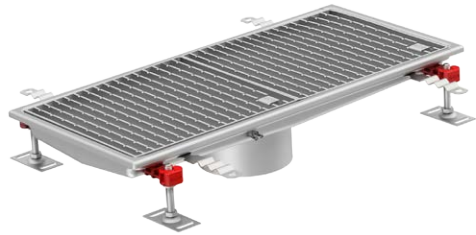

ACO hygienic gully



ACO pipe



2.2.2.4. Example layouts

Storage area

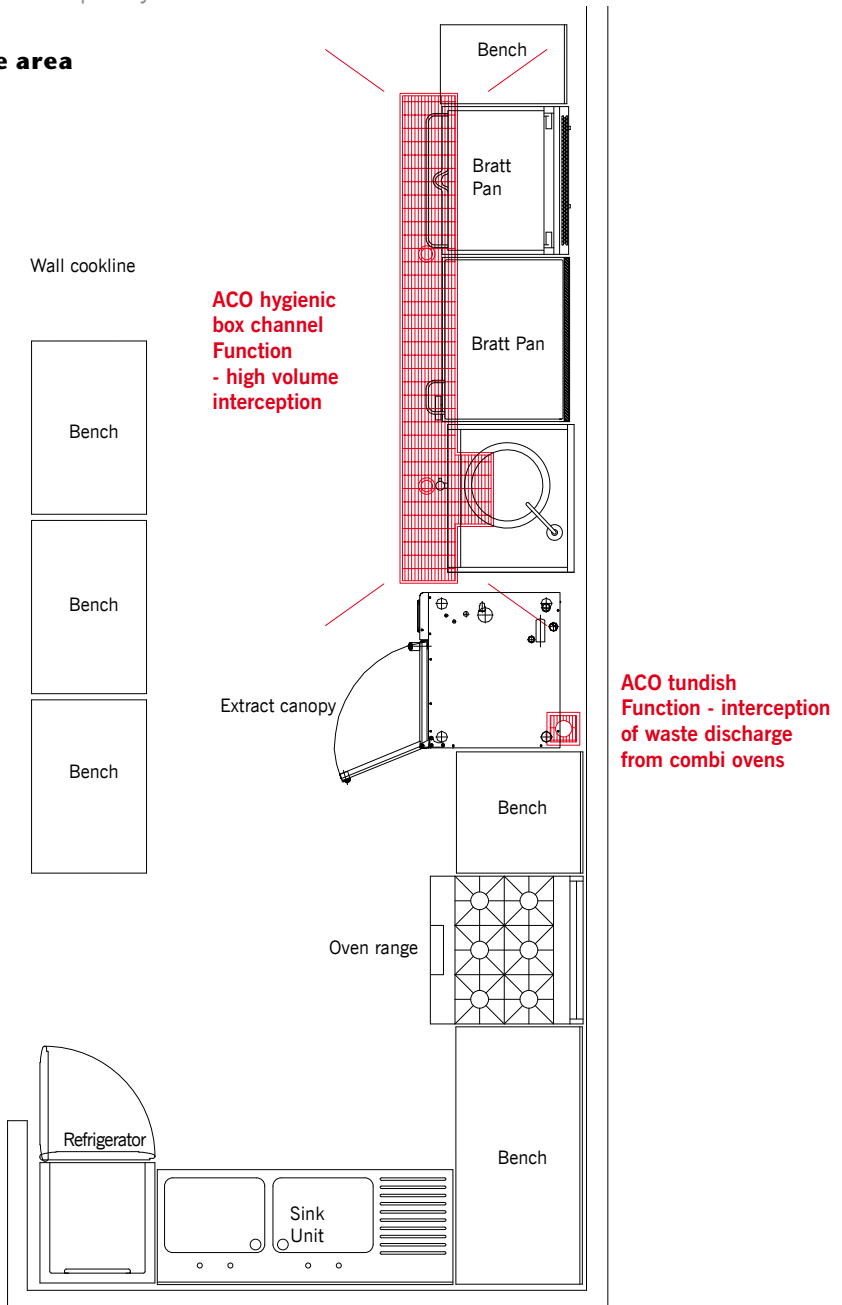

Mid size cookline

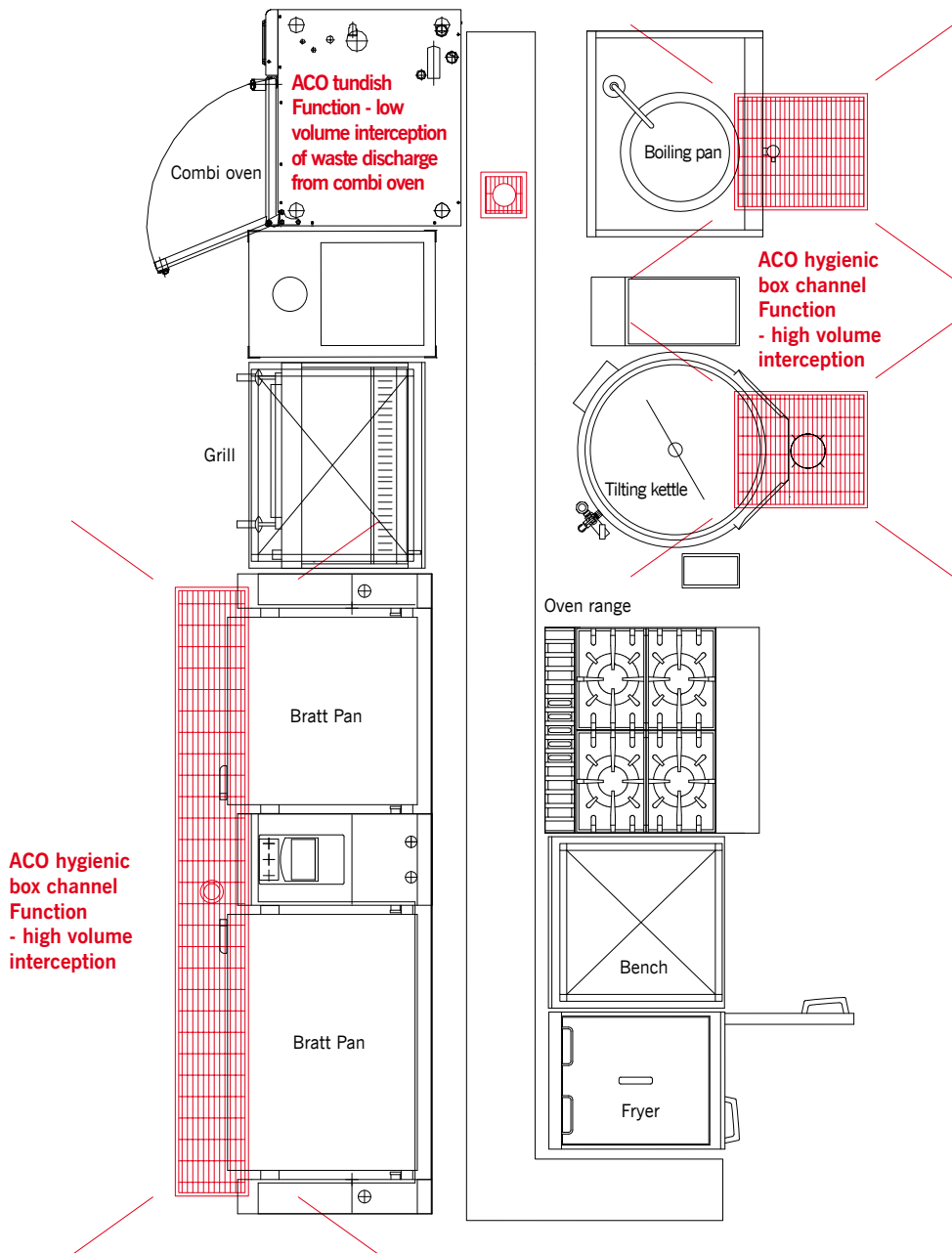

2.2.3. Washing and disposal area

2.2.3.1. Description

Dishwash area

The ware-washing area will be the wettest area of the kitchen operation. The process will involve the removal of residual food, space needed scraping, pre-soaking, rinsing and washing stages.

Care must be taken to reduce the build up of fats, oils and grease (FOG) in drainage plumbing (see drainage treatment), and while grease separators offer solutions, simply wiping off food residues can have a dramatic impact on overall drainage functionality. All drainage plumbing should be routed to a grease separator designed and tested in accordance with EN 1825 parts 1 and 2, ideally situated close to source.

Floor drainage also features predominantly in these areas, specifically in front of larger conveyor or 'flight' type washers, or centrally in any dishwash or potwash area

- ACO hygienic box channel runs are useful in front of 'flight' type dishwashers
- wastewater should be treated for removal of fats, oils and grease (local regulations vary - check with your local authority)
- wastewater should be treated for removal of food debris and ideally sediment or debris baskets should be used at the outlet in every gully or channel run.

2.2.3.2. Appliances

Disposal area

This area (when included within a facility) shall be accessible from the kitchen area and also directly from the external yard to allow removal of the waste without the requirement for entering the kitchen. Ideally the disposal area will be separated from preparation and storage areas. It shall be used to store waste for short durations prior to being collected for recycling or disposal.

Due to the high risk of food liquids and other substances being spilt or deposited on the floor internal & external disposal areas or rubbish stores must have a drainage gully with slip resistant gratings and the means to clean the area.

**External areas for waste bins should be specified for larger point loads
– with ACO hygienic box channel to EN 1433, and ACO hygienic gullies to EN 124,
Load Class N 250 where heavier vehicles are expected such as waste trucks.
In all situations there should be access to a water supply for the cleaning down
of spillages or leaks, therefore the ACO hygienic gully or hygienic channel is vital.**

2.2.3.3. Appliances

Dishwashers

There are many different types of dishwasher ranging from under counter units that can provide glass washing and ware washing to pass through machines, flight dishwashers and utensil washers. They all carry out the same basic function being that of washing the crockery, glasses or utensils.

Under Counter

These tend to be front-loading compact machines for small to moderate usage of glasses, or crockery, often fitting under a counter or on a bench in a kitchen area. Being compact leads to fast turnaround and avoiding the need for large stocking levels of crockery or glasses.

Drainage can be pumped which sometimes allows them to be sited some distance from a drain point. Drainage can be a direct connection, although in many bar locations with multiple pieces of equipment discharging to a single drain, a hygienic gully with a tundish is used allowing better cleaning access. In these instances this needs to be suitably catered for with an ACO hygienic gully complete with ACO tundish fitting.



Rack Pass Through

This tends to be the next stage up in machine design, and typically has a pull-down hood. These are more powerful, faster and are manually loaded with a basket of soiled tableware. They are usually configured with stainless steel tabling either side of the dishwasher so while a basket of tableware is being washed, another basket of dirty tableware is being loaded ready to go in, and a washed basket on the other side of the hood washer is waiting to be emptied. This gives a continual cycle of plate washing.

This is where you would use an ACO hygienic gully and ACO hygienic box channel.



Flight Dishwasher

These are a semi-automatic dishwashing systems. Used in a range of locations from Hospitals, and large airline catering facilities to education or staff feeding where large numbers are being fed in a short period of time.

In large facilities a number of these types of machine can be linked together using a series of conveyors to create a very busy and wet operational area.

In these locations ACO hygienic gully and ACO hygienic channel are arranged to suit the layout of the room and functionality of the system in place.



Utensil Washer

These machines are specifically designed for the washing and cleaning of the utensils, pots and pans used during the cooking process.

They can in addition be used for the washing of excess crockery, although the dishwashers described previously would be a more efficient machine for this purpose.

A Utensil washer is the next step up from a large double basin pot wash sink, and by the sheer nature of the operation being that of the cleaning of large pots, pans and trays a volume of water is spilled on the floor. **Any utensil wash area should be equipped with a ACO hygienic gully as a minimum, and more ideally with a suitably sized ACO hygienic channel to ensure that the floor surface stays as dry and clean as possible.**



2.2.3.4. Typical drainage products

ACO hygienic gully

ACO hygienic box channel



ACO grease separator



ACO pipe



2.2.3.5. Example layouts

Dishwash area

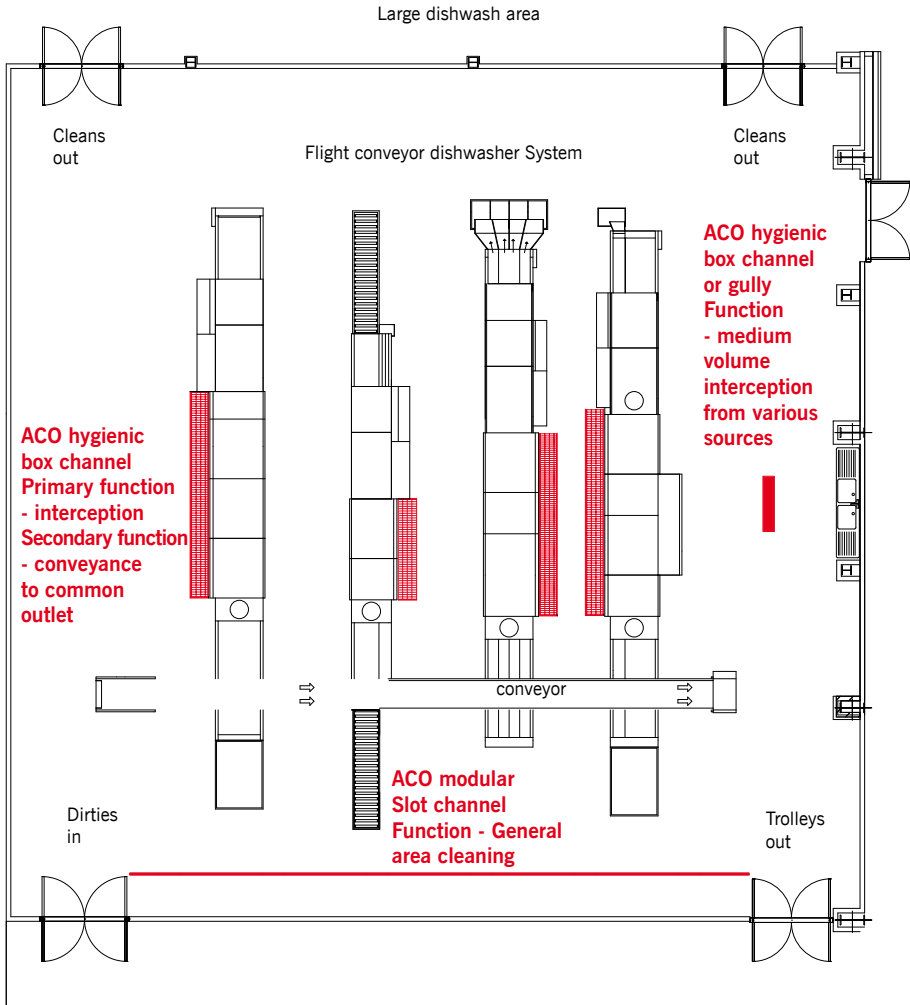

Dishwash area

Small dishwash area

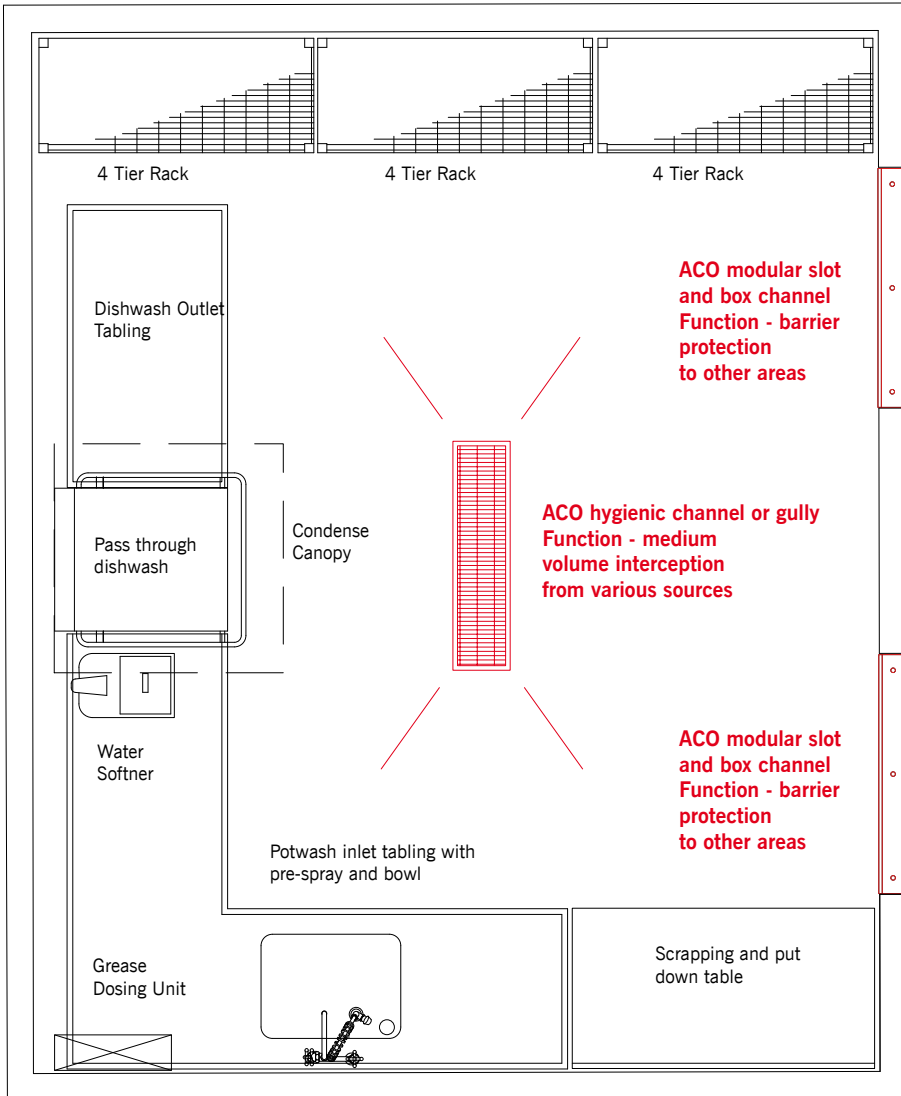

Disposal area

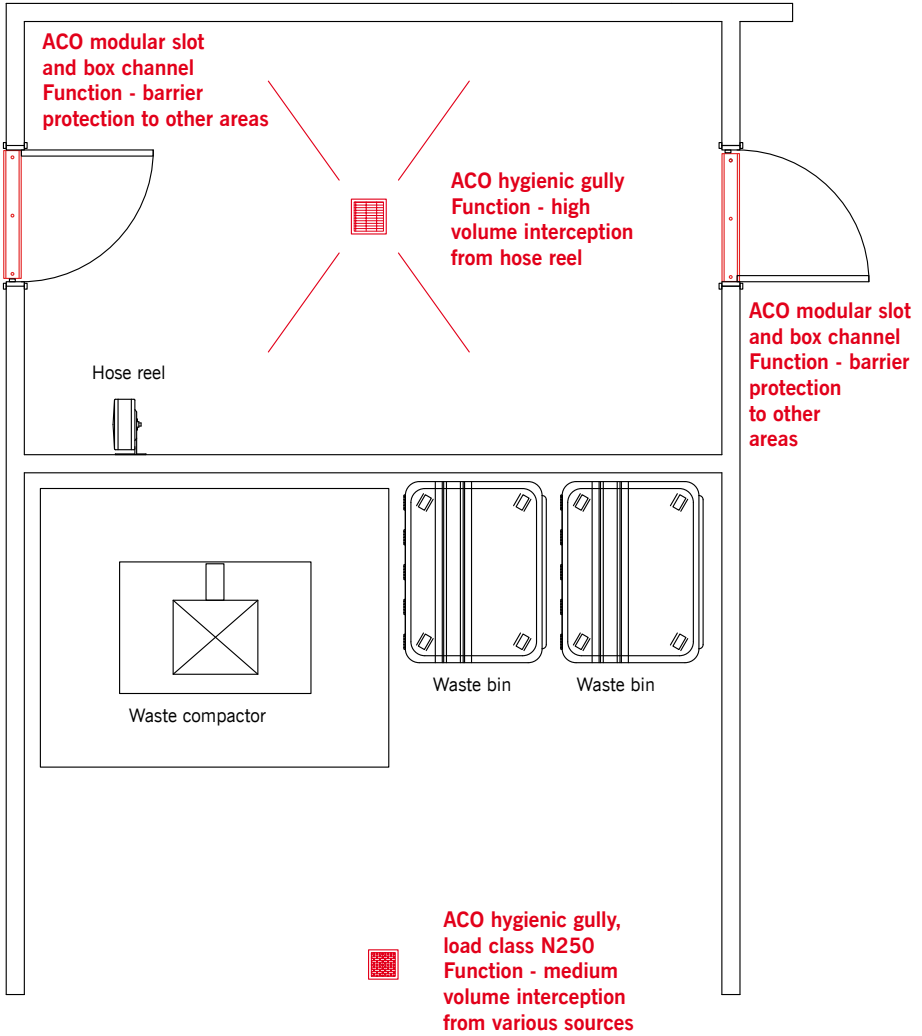



RAISING THE INDUSTRY STANDARDS



3. Drainage, Grease and Waste management

3.1. Drainage management

- 3.1.1. Introduction
- 3.1.2. Drainage selection guide
- 3.1.3. ACO hygienic gully
- 3.1.4. ACO hygienic box channel
- 3.1.5. ACO modular box and channel
- 3.1.6. ACO pipe
- 3.1.7. ACO grating system overview
- 3.1.8. ACO tundish

3.2. Grease management

- 3.2.1. Introduction
- 3.2.2. ACO grease separators

3.3. Organic waste management

- 3.3.1. Introduction
- 3.3.2. ACO waste disposal system

3.4. Related products

- 3.4.1. ACO lifting plant
- 3.4.2. ACO access cover

3.1. Drainage management

3.1.1. Introduction

Hygienic standards in the commercial kitchen industry are rising. ACO is meeting these changing demands by incorporating hygienic design principles, industry best practice and the guidelines of bodies including the European Hygienic Engineering and Design Group (EHEDG) into the design of its drainage solutions.

Operational costs are a major factor in business today. Every product and system needs to fulfil its function efficiently throughout its entire lifespan. ACO provides the expertise and quality necessary to provide the perfect balance between high levels of food safety and operational cost.

The kitchen is a potentially hazardous environment because of the ever-present element of heat, liquids and grease. ACO drainage systems are specifically designed to reduce the build-up of liquids by disposing of water and grease effectively and immediately.

Food safety features of ACO drainage

ACO hygienic drainage fulfils hygienic requirements to prevent harmful bacteria contamination. We apply relevant hygienic design principles reserved for food contact surfaces recommended by EHEDG.

Our product design ensures minimal build-up of food particles and debris as well as a safe connection with the surrounding floor to minimise any opportunity for bacteria to grow throughout the drainage system.

Sleek slope function and hygienically designed products ensure our system is fully drainable eliminating the stagnant odour of waste water.

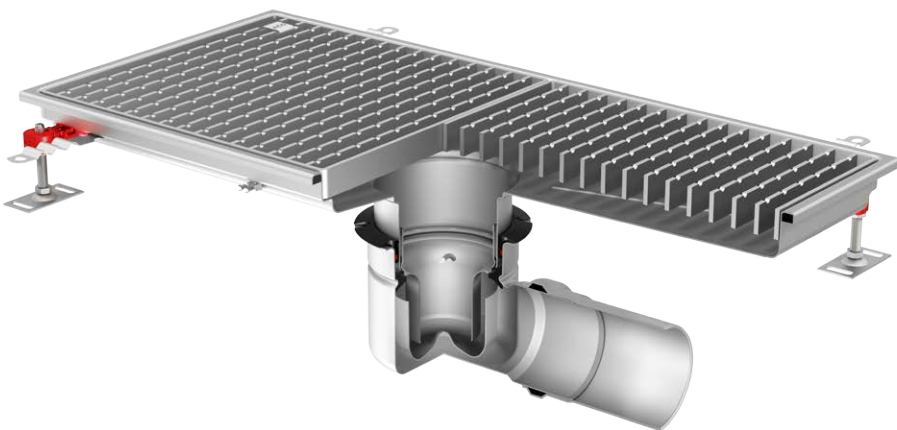
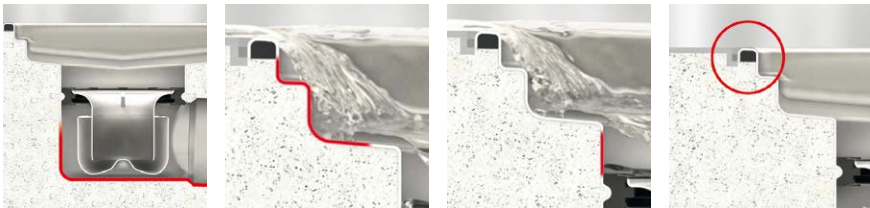

Cost control features of ACO drainage

ACO drainage system can be easily maintained, reducing associated cleaning costs thanks to their functional design and cleaning recommendations which have been developed in partnership with premium cleaning agent suppliers.

ACO's advanced manufacturing technologies ensure durability and our special surface treatment guarantees corrosion resistance. Our systems perform effectively at all times and keep disruption to a minimum.

We provide expertise in drainage system planning, correct installation and creating a safe connection with the surrounding floor to avoid unnecessary cost.

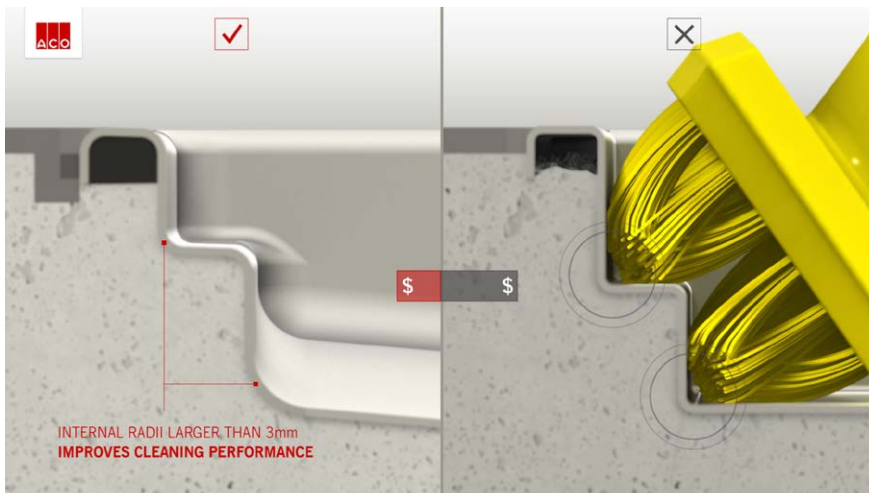

Health & Safety features of ACO drainage

For additional safety in high risk areas that require heavy water usage, non slip ladder and cast gratings are available.

Each component of the drainage system is easy to remove and clean, and there are no sharp edges for optimum employee safety.

ACO drainage products have a fire resistant solution certified according to EN 136.

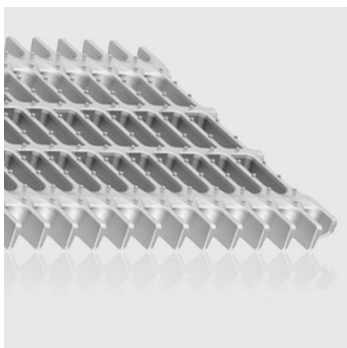
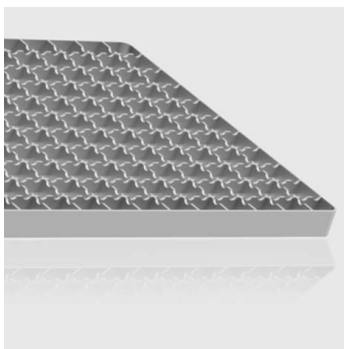
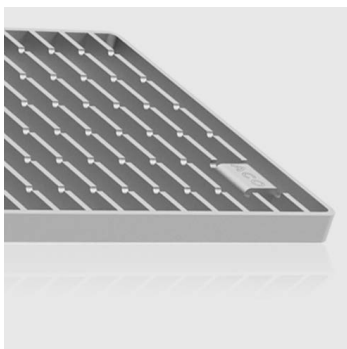

3.1.2. Drainage selection guide

3.1.2.1. Drainage type

Based on the basic application, the type of drainage needs to be selected according to the layout of the operational space and technology employed.

Point drainage







Linear drainage

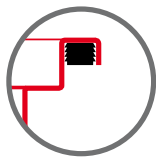
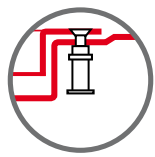
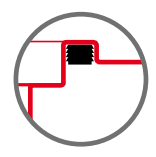
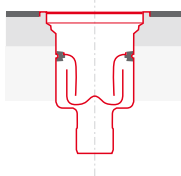

3.1.2.2. Floor structure and finish

Depending on the composition of the floor construction; the appropriate type of gully or channel should be selected. If there is insulation in the floor structure, the O-ring needs to be removed from the friction ring, which will allow the water from the insulation to be drained to the gully body.

Depending on the floor finish; the appropriate edge of the channel or gully top should be selected.

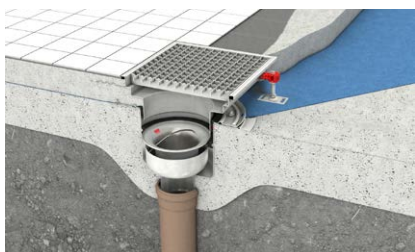
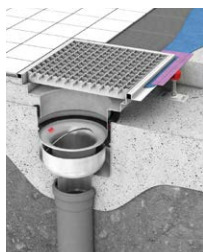
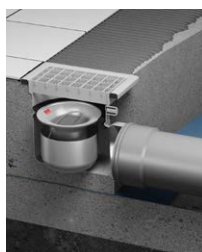
Channels + Telescopic gullies			Fixed height gullies
FLOOR FINISH			
Tiled, concrete or resin floor	Vinyl	Tiled (thin bed installation)	Tiled, concrete or resin floor
CHANNEL OR GULLY EDGE			
Standard edge	Vinyl edge	Extended edge	Standard edge
CHANNEL OR GULLY TOP DRAWING			
			
WATERPROOF MEMBRANE CONNECTION			
Connected to gully body		Connected to channel /gully top	Independent of the gully
GULLY BODY TYPE			
Telescopic adjustable Adhesive bonding flange or mechanical clamping flange		Telescopic adjustable Location flange	Fixed height gully
			
INSTALLATION EXAMPLE			
			

3.1.2.3. Retention capacity

Depending on the application, the appropriate retention capacity should be considered.

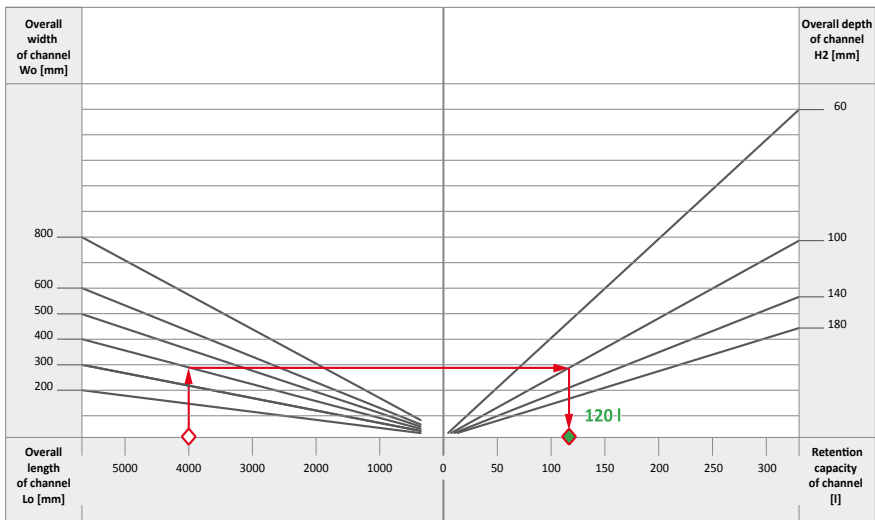

3.1.2.4. Channel geometry

Based on the retention capacity considered, as well as the floor structure, the particular dimensions of a channel or gully top (for telescopic solution) need to be specified.

For the channel a construction height at the outlet position as well as the position of the outlet and the height of the endcaps has to be defined.

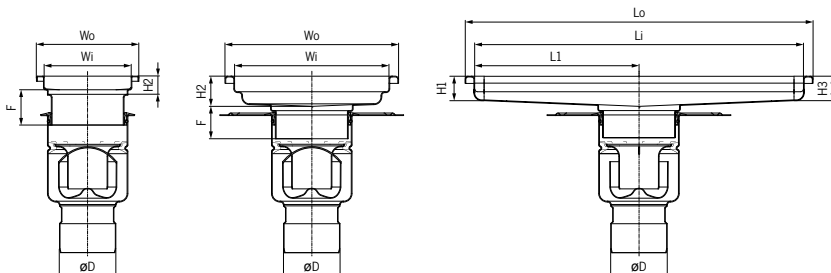

3.1.2.5. Flow rates

Flow rates reflect the system's ability to constantly drain a certain amount of water. Flow rate is generally defined by the ACO gully size.

Flow rates

Outlet position	Gully type	Outlet diameter [mm]	Minimal flow rate [l/s]
Vertical outlet	142	70/75	1.4
		100/110	1.6
	157	70/75	2.7
		100/110	3.5
	218	100/110	5.0
		150/160	5.0
	EG150	70/75	1.2
		100/110	1.2
Horizontal outlet	142	70/75	1.4
		100/110	1.6
	157	70/75	2.6
		100/110	2.8
	218	100/110	4.4
	EG150	70/75	1.2

Flow rates are measured according to EN 1253. Flow rate performance is without silt basket (flow rates with empty silt basket are approximately 15% lower than the values stated)

3.1.2.6. Accessories

For the collection of solid parts, the gully or channel should be fitted with a silt basket.

Telescopic connection without flange for waterproofing	Telescopic connection with flange for waterproofing		
ACO gully EG150	ACO hygienic gully 142	ACO hygienic gully 157	ACO hygienic gully 218
Accessories delivered as standard with the gully			
<ul style="list-style-type: none"> ▪ Friction ring 	<ul style="list-style-type: none"> ▪ Friction ring ▪ Foul air trap ▪ Foul air trap support 	<ul style="list-style-type: none"> ▪ Friction ring ▪ Foul air trap ▪ Foul air trap support 	<ul style="list-style-type: none"> ▪ Friction ring ▪ Foul air trap ▪ Foul air trap support
Optional accessories			
<ul style="list-style-type: none"> ▪ Sieve ▪ Foul air trap with silt basket ▪ Foul air trap 	<ul style="list-style-type: none"> ▪ Silt basket for fixed height gully 0.3 l ▪ Silt basket for telescopic gully 0.4 l 	<ul style="list-style-type: none"> ▪ Silt basket for vertical gully 0.6 l ▪ Silt basket for horizontal gully 0.3 l 	<ul style="list-style-type: none"> ▪ Silt basket for vertical gully 1.4 l ▪ Silt basket for horizontal gully 0.7 l

3.1.2.7. Gratings





For the choice of the appropriate grating, the following properties have to be considered:

- Hygiene (cleanability)
- Load class
- Slip resistant

	Cast grating	Ladder grating		Mesh grating	
	Slip resistance	Slip resistance	Plain	Slip resistance	Plain
Slip resistant Pendulum test BS 7976-2	Low	Low	Moderate	Low	Moderate
Slip resistant Ramp test DIN 51130	R13	R11	R9	R11	R9
Load classes	M 125	R 50, M 125	R 50, M 125	L 15	L 15

3.1.2.8. Load class

Though it is recommended to avoid traffic across the drainage items to minimize risk of floor/drainage connection failures by dynamic loading; proper load class defined by grating has to be considered based on the defined traffic during future operation.

Load class Application	Load class according to EN 1253	Description
	<p>L 15</p>	<p>Areas with light vehicular traffic, such as:</p> <ul style="list-style-type: none"> ■ In commercially used premises and public areas
	<p>R 50*</p>	<p>Areas with vehicular traffic, such as:</p> <ul style="list-style-type: none"> ■ In commercially used premises and factories
	<p>M 125</p>	<p>Areas with vehicular traffic such as:</p> <ul style="list-style-type: none"> ■ Workshops, factories & car parks
	<p>N 250*</p>	<p>Heavy duty industrial areas subject to forklift traffic, such as:</p> <ul style="list-style-type: none"> ■ Food processing areas, chemical or process plants

* New load classes in EN 1253-1 (enter into force in 2015)

SAFE AND DURABLE
WITH NO COMPROMISE
TO HYGIENIC PERFORMANCE



3.1.3. ACO hygienic gully

3.1.3.1. Hygienic design

ACO hygienic drainage fulfils strongest hygienic requirements to prevent harmful bacterial contamination. We apply the relevant hygienic design principles reserved for food processing equipment EN 1672, EN ISO 14159 and EHEDG document No. 8, 13 and 44 to the gully design.

ACO gully hygienic features:

- Full drainability
- Internal radii equal or larger than 3 mm
- Hygienic joints
- Edge infill
- Stainless steel grade min. 1.4301 according to EN 10088 (304 according to AISI)
- Fully pickled and passivated



All internal radii equal or larger than 3mm which greatly increases cleaning effectiveness

Full drainability: Dry sump design, completely drainable - eliminating stagnant water, smells, microbial growth and potential chemical hazards.

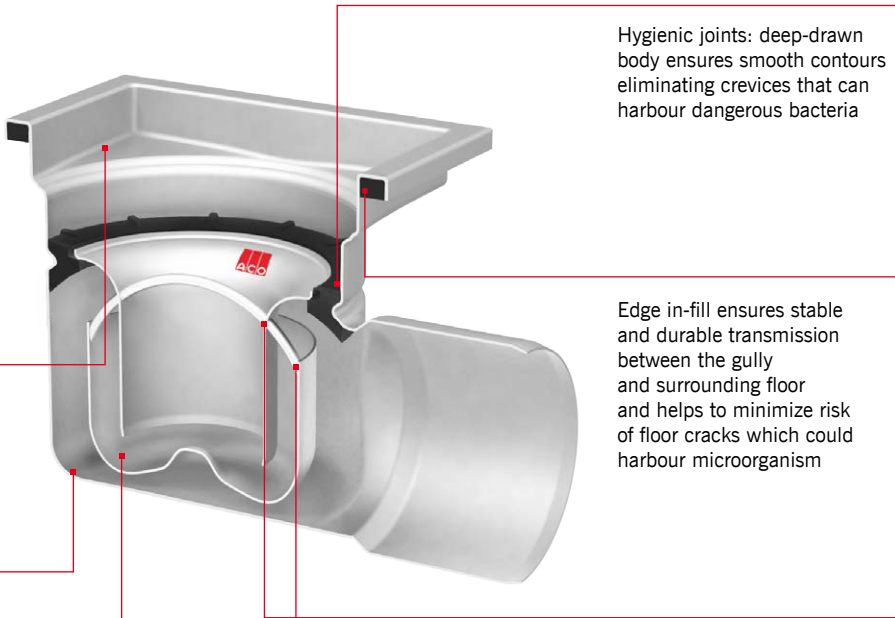
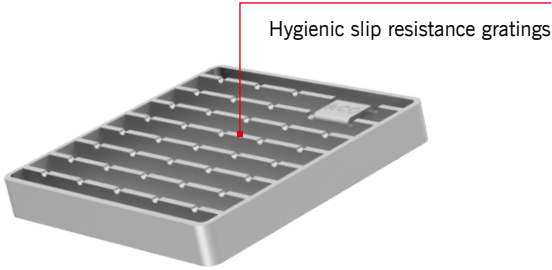

3.1.3.2. ACO hygienic gully system overview

ACO gully range is available in a number of versions featuring different flow rates, grating designs, sizes and spigot outlet diameters to suit various applications.

The floor construction and depth together with the use of any waterproofing membrane play an important role in the selection of the appropriate type of gully.

The ACO gully range is available with vertical or horizontal spigot outlets.

Fixed height gullies are convenient and free-standing units which are suitable for cementitious, resin or tiled floors.

Telescopic gullies can be installed either with a gully top or ACO channel in most flooring constructions, including floors with waterproofing membranes.

- 1** Grating
- 2** Silt basket
- 3** Foul air trap
- 4** Foul air trap support
- 5** ACO gully body
- 6** Gully top
- 7** Friction ring
- 8** Leveling feet

Fixed height solution

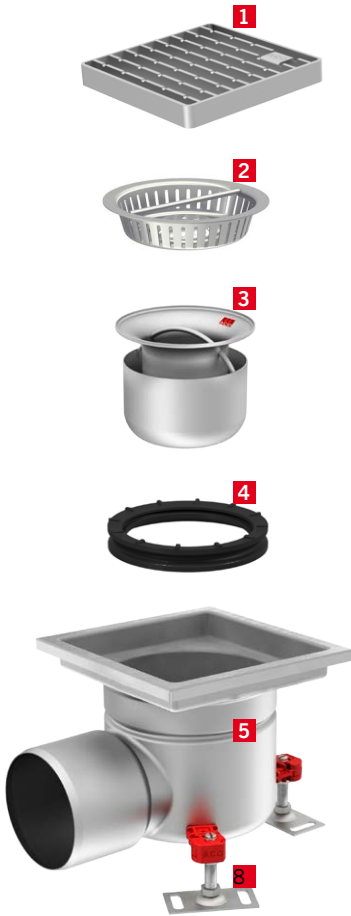

Telescopic solution



3.1.4. ACO hygienic box channel

3.1.4.1. Hygienic desing

ACO offers sustainable, integrated drainage systems which are designed to protect your business, the environment and ultimately public health. Our aim is to constantly improve every aspect of safety, hygiene and functional performance.

We believe that our systems and services are truly unique, delivering unparalleled benefits to everyone involved in project delivery or subsequent operation.

ACO hygienic drainage fulfills stringent hygienic requirements to prevent harmful bacterial contamination. We apply the relevant hygienic design principles reserved for food contact surfaces EN 1672, EN ISO 14159 and EHEDG document to the channel design.

ACO channel hygienic features:

- Fully drainable
- Internal radii equal or larger than 3 mm
- Hygienic joints
- Edge infill
- Stainless steel grade min. AISI 304
- Fully pickled and passivated

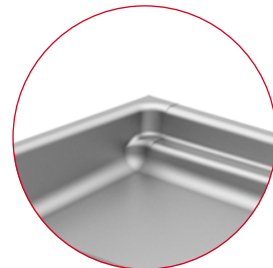

All internal radii equal or larger than 3mm which greatly increases cleaning effectiveness

Edge in-fill ensures stable and durable transmission between the gully and surrounding floor and helps to minimize risk of floor cracks which could harbour microorganism

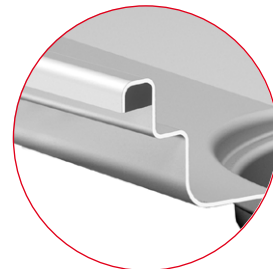

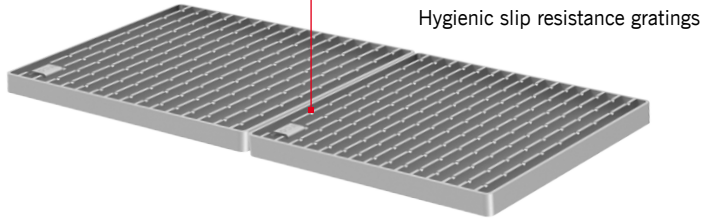

Hygienic slip resistance gratings

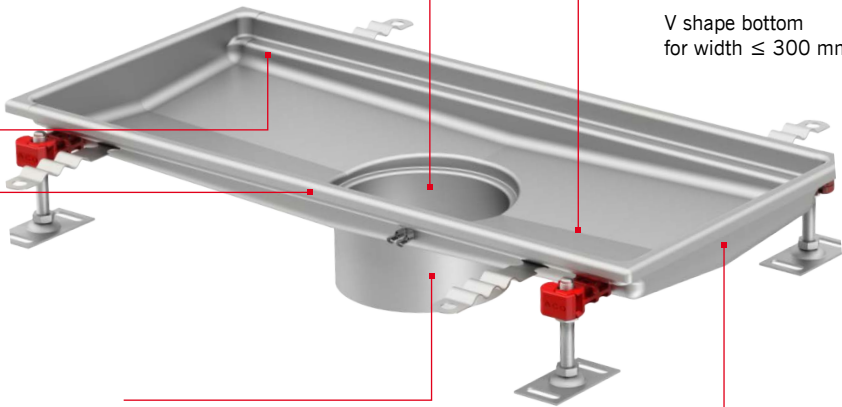

Hygienic joints: deep-drawn
body ensures smooth contours
eliminating crevices that can
harbour dangerous bacteria

V shape bottom
for width ≤ 300 mm

Full drainability: Dry sump
design, completely drainable
- eliminating stagnant water,
smells, microbial growth
and potential chemical hazards.

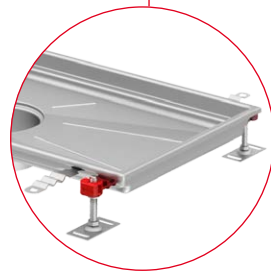

Reinforced bottom
for width ≥ 400 mm

3.1.4.2. ACO box channel system overview

ACO box channel - fixed height solution

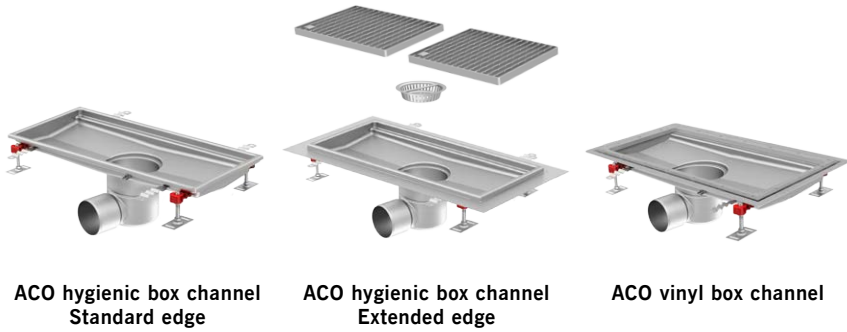

ACO box channel - telescopic solution

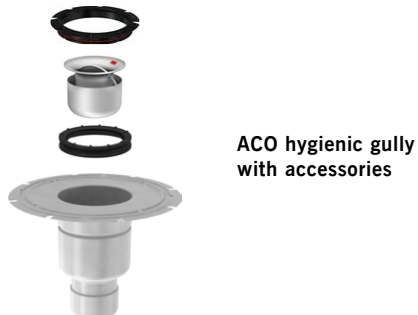
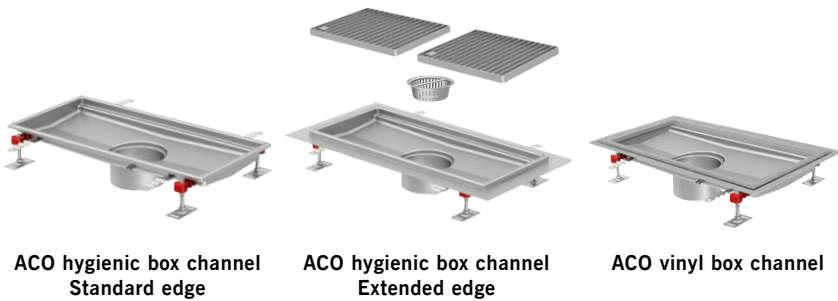

3.1.5. ACO modular box and channel

3.1.5.1. Introduction

The ACO modular channel range includes channels for all common applications and all common floor types (concrete, tiles, resin or vinyl).

Selecting a channel from the range is easy. The unique variability of the whole portfolio makes it easy to choose the right channel according to a specific customer's needs.

Channel's length, depth and outlet position are just a few of the parameters which can be varied and, regardless of the variations specified, there is no impact on delivery lead times.

3.1.5.2. System overview

ACO modular channel system overview

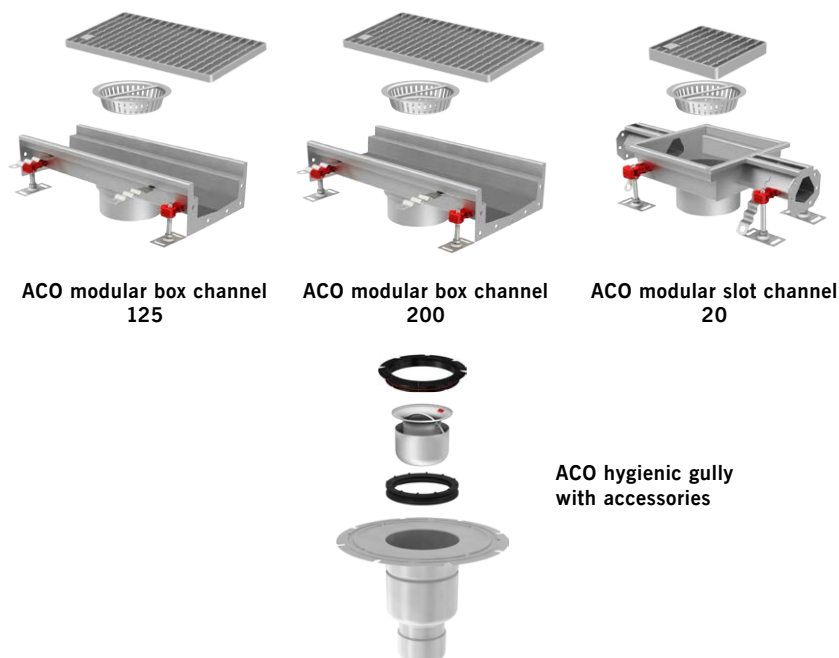

3.1.5.3. ACO modular box channel system overview

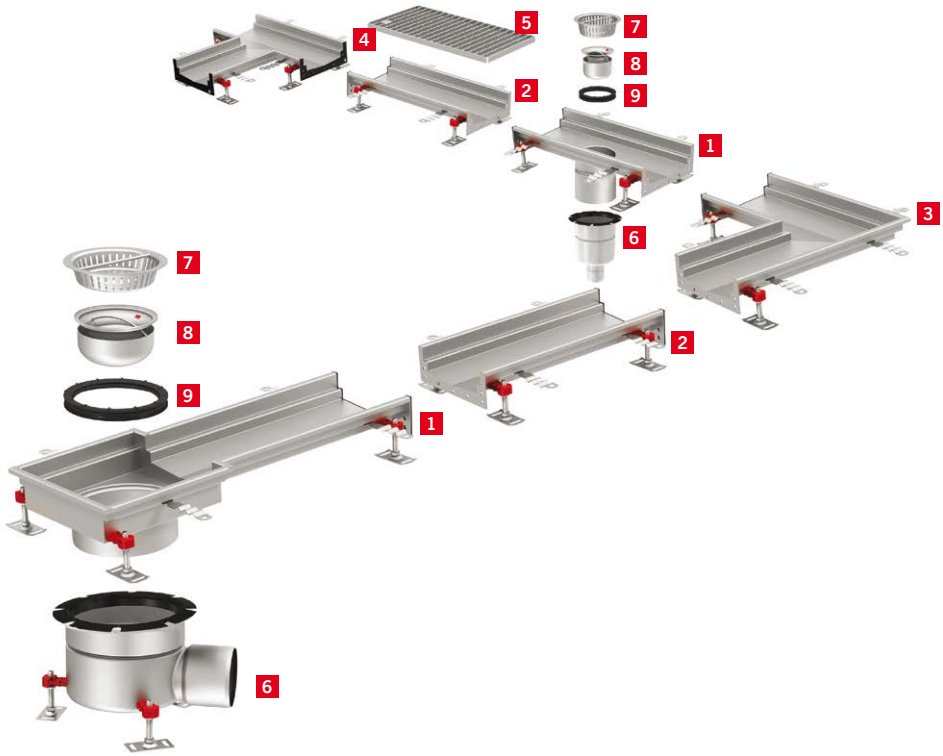

3.1.5.4. ACO modular slot channel system overview

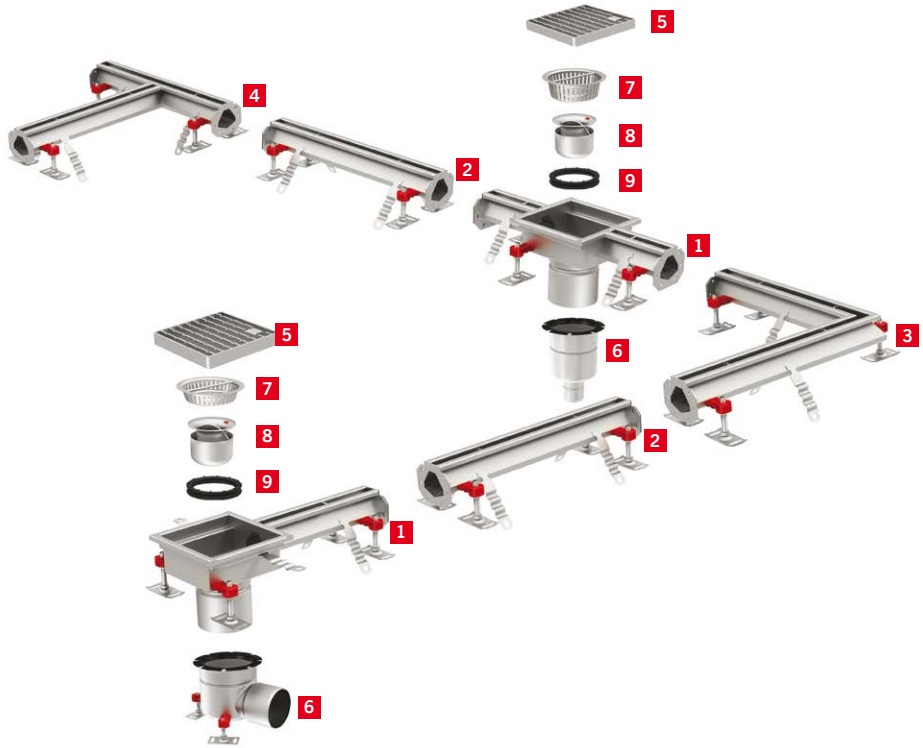

- 1** Outlet unit
- 2** Level invert and sloping invert channel
- 3** Corner unit
- 4** Branch unit
- 5** Grating

- 6** Hygienic gully
- 7** Silt basket
- 8** Foul air trap
- 9** Foul air trap support

3.1.6. ACO pipe

3.1.6.1. Introduction

ACO pipe is a reliable, lightweight and durable push-fit pipework system, designed, produced and tested for soil, waste, rainwater and industrial wastewater drainage applications. Together with the other products of ACO Group it creates a perfect system for building drainage and offers a sustainable drainage solution with unique advantages to the customers.

The push-fit system ensures quick and easy assembly for a reliable installation for gravity and vacuum drainage. All ACO pipe interconnecting seals and fittings incorporate a unique double sealing system providing a trouble-free and reliable sealing solution – every time. The wide range of fittings available utilizes advanced cold forming techniques, thereby reducing the manufacturing cost and minimizing the amount of welded components, to provide the ultimate in system reliability.

ACO pipe stainless steel pipes and fittings are available in 50 mm, 75 mm, 110 mm, 125 mm, 160 mm, 200 mm and 250 mm external diameters with the standard lengths from 0.15 meter up to 6 meter for optimum practicality and ease of assembly.

European Standards for stainless steel pipes:

ACO tests pipes to EN 1124–1 and EN 1124–2 Pipes and fittings of longitudinally welded stainless steel pipes with spigot and socket for waste water systems.





3.1.6.2. ACO pipe system overview



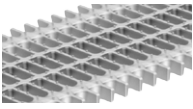
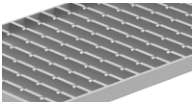
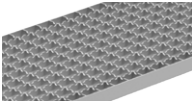
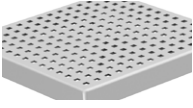
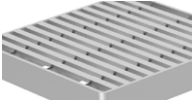
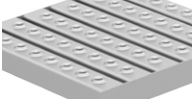
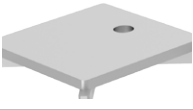
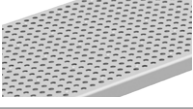

Please find detailed information and relevant article numbers in ACO pipe catalogue or at www.aco-industrialdrainage.com

3.1.7. ACO grating system overview

Grating		ACO hygienic gully	ACO hygienic box channel	ACO modular slot channel	ACO modular box channel	Load class up to
	ACO hygienic cast grating	✓	✓	✓	✓	M125
	ACO hygienic ladder grating	✓	✓	✓	✓	N250
	ACO mesh grating	✓	✓	✓	✓	L15
	ACO quadrato grating	✓		✓	✓	L15
	ACO heelsafe grating	✓		✓	✓	L15
	ACO multi- slot 5 grating	✓		✓	✓	L15
	ACO slot cover	✓		✓		M125
	ACO perforated grating				✓	L15
	ACO plastic grating				✓	L15

3.1.8. ACO tundish

The tundish is required where prevention of splashing or aerosol formation is important. The tundish also provides a vital air gap between the equipment and the drain, and is often the preferred method for draining of combination ovens, steaming units, boilers and cafe sets. Attached covers can be specified as a grating - to receive surface fluids, or solid - to serve the connected equipment only.



VITAL AIR GAP BETWEEN
THE EQUIPMENT AND THE DRAIN





EFFECTIVE HYDRO MECHANICAL
HIGH PRESSURE 360° INTERNAL CLEANING

3.2. Grease management

3.2.1. Introduction

Commercial kitchens generating waste water must have pre-treatment plants to ensure that solids and liquids that release harmful or unpleasant vapours or interfere with operations are not discharged into the public sewerage network.

In addition to odour reduction, ACO systems also reduce the amount of work required to handle grease disposal and cleaning. For example, if a grease separator features automated cleaning, it is no longer necessary to use external cleaning equipment.

The use of the filling device also allows refilling to take place directly at the separator.

Health & Safety is of prime importance in a commercial kitchen operation with particularly attention being paid to process reliability and fire prevention.

Food safety features of ACO grease separators

System ACO grease separators eliminate unpleasant smells during cleaning and disposal.

Effective hydro mechanical high pressure 360° internal cleaning (175 bar) removes all residue in the separator.

For optimal hygienic performance, stainless steel separators are also available.



Cost control features of ACO grease separators

ACO grease separators automatically measure the grease layer, so the operator knows when they need emptying.

Operational flexibility is ensured by our GSM Mobile module. Information about inspections and maintenance needs are sent to mobile phones.

Operational cost are optimised due to automatic cleaning and grease disposal.

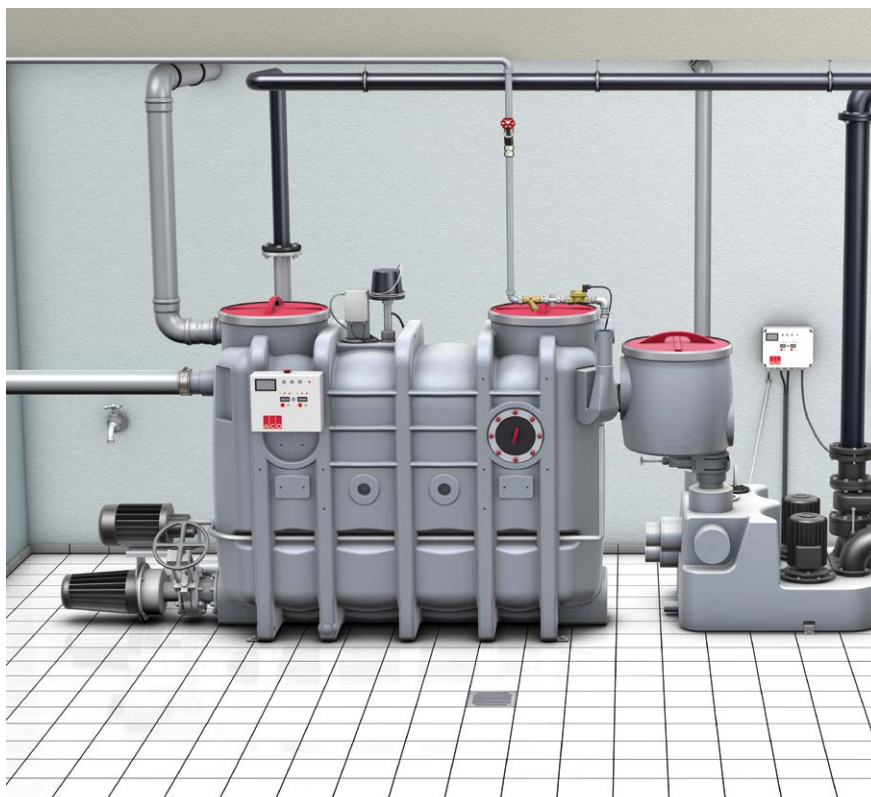

Health & Safety features of ACO grease separators

Benefiting from automatic cleaning, ACO's grease separator eliminates any health and safety risk during disposal and cleaning.

Sizing, layout and the right solution specification support ensure safe installation and maintenance.

ACO grease separators offer a stainless steel incombustible solution.

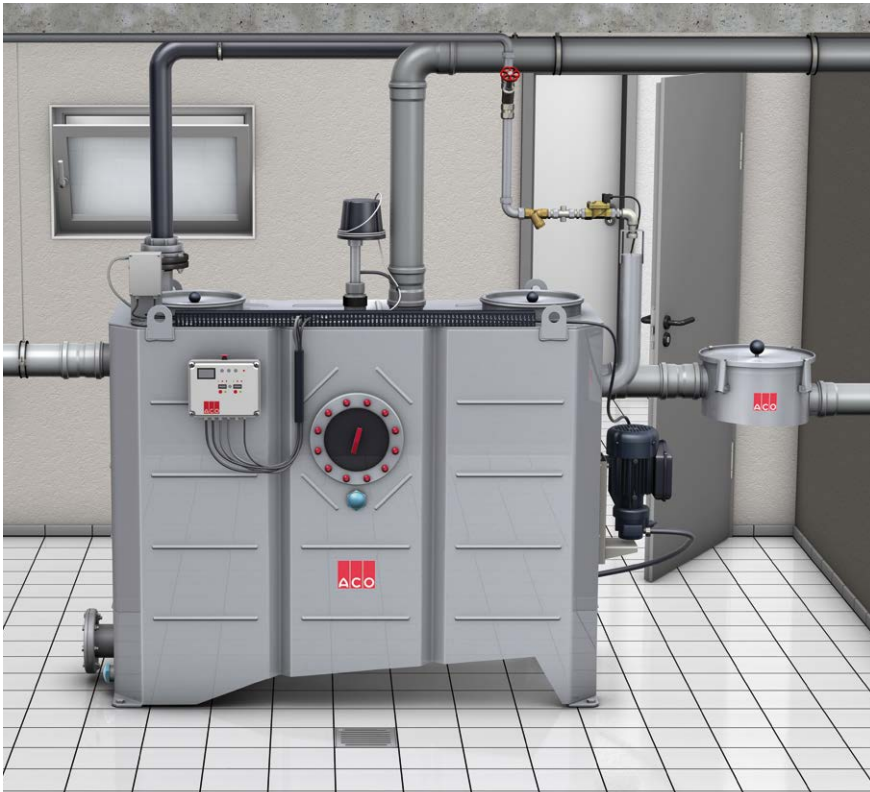

3.2.2. ACO grease separators

ACO Grease separators according to European Standard (EN) 1825 rely on the relative density naturally present in the influent. FOGs, whilst wide ranging in relative density, are always less dense than water and naturally float on the surface of the water within the separator unit. Similarly, solid particulates common to most cooking processes are denser than water and sink to the separator base.

The standard prescribes the various separator compartment dimensions, which are a function of the required flow through the separator. Conveniently, the design section of the Standard allows the specifier to arrive at a single figure expressed as nominal size (NS), which relates to the flow through the separator in litres per second. A secondary “figure” is also derived which relates specifically to the size of the solids retention compartment – thus a typical specification would read “NS 7” – 700 relating to a separator capable of sustaining 7 litres/second flow and with solids capacity of 700 litres.

Disposal types

FOGs and solids are retained inside the grease separator. FOGs and solids must be periodically removed from the grease separator to prevent blockage. Usually, certified recycling companies use disposal trucks to empty the entire contents of the separator. The choice of the disposal types mainly depends on two questions:

- Are suction trucks available?
- Is the interruption of operations (for example: 24-hour kitchen) permissible?

Therefore there are two types of grease separators available: Grease separators for complete disposal (full disposal) and grease separators for partial disposal (fresh grease separators).

Grease separators for complete disposal

ACO grease separators for complete disposal usually have to be emptied at least every four weeks. For that purpose a recycling truck has to remove the entire separator content via a suction line. Once emptied, the grease separator has to be cleaned and refilled with clean water and then operation in the kitchen can start again.

ACO full disposal grease separators are made of polyethylene or stainless steel and can optionally be equipped with a suction line, high pressure cleaning and a disposal pump. The separators can be built in oval or round design according to project specifications.



Grease separators for partial disposal

ACO partial disposal grease separators for partial disposal separate the FOGs and solids from the wastewater into discrete collecting drums by opening the relevant drainage valve on the separator body (specifics depend on the type of operation). This can be undertaken independently of normal operations and can be done without interruption to the kitchen.

Because the collecting drums only take grease and sludge, the grease separator does not have to be filled after disposal with expensive fresh water.



3.3. Organic waste management

3.3.1. Introduction

Organic waste management is an important task within commercial kitchen operation, where food is handled and waste is produced. Food waste can create food hygiene risks whether stored in local containers, double bagged within external bins or during transportation and its handling can be a time, energy and space consuming process.

Therefore the management of food waste needs to be considered as a specific issue within commercial appliances. Current management of food waste is carried out in conjunction with Multi Activity Contractors to include the in house management, collection, processing, segregation, marketing and sale of reclaimed materials and arranging the disposal of final waste residues.

Operators of commercial kitchens should address the management of food waste and consider ways to reduce costs and alternative sustainable food waste disposal methods. The Waste Disposal System “ACO Waste Jet” allows storage and disposal of food stuff and can be used to solve the most important mentioned problems.

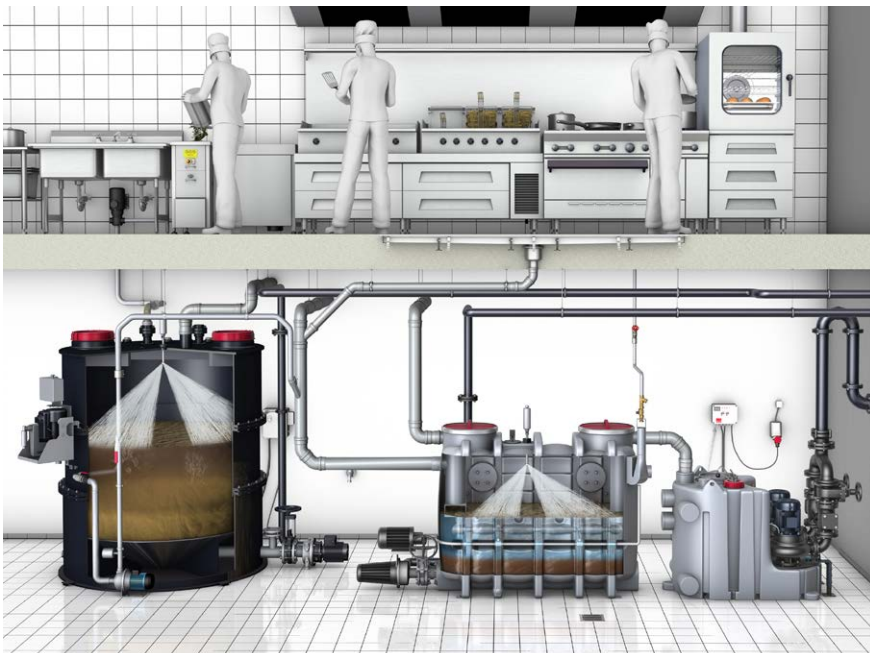

Food safety features of ACO Waste-Jets

The use of the ACO Waste-Jet wet refuse collection system creates a closed hygiene chain from the point of origin to a collection tank which takes the refuse directly into a storage tank.

No waste bins are needed in the kitchen, meaning that cross-contamination during their removal from the clean area is eliminated and infestation by pests or maggots is prevented.

Tanks used in the ACO Waste-Jet wet refuse collection systems are sealed and odour-proof. This system also ensures elimination of unpleasant smells from the free stored organic waste.

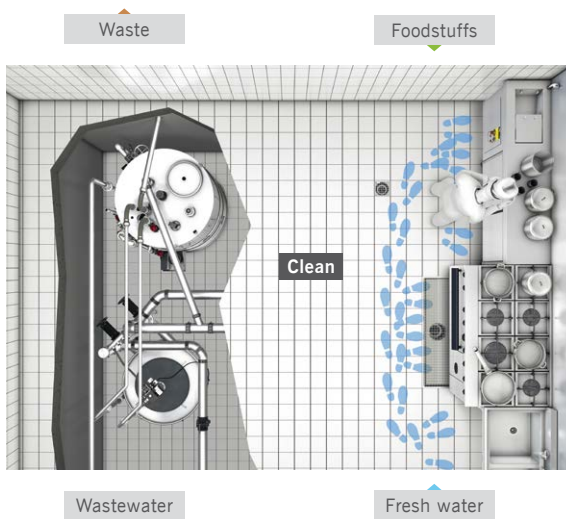

Modern refuse management using ACO Waste-Jet wet refuse collection systems

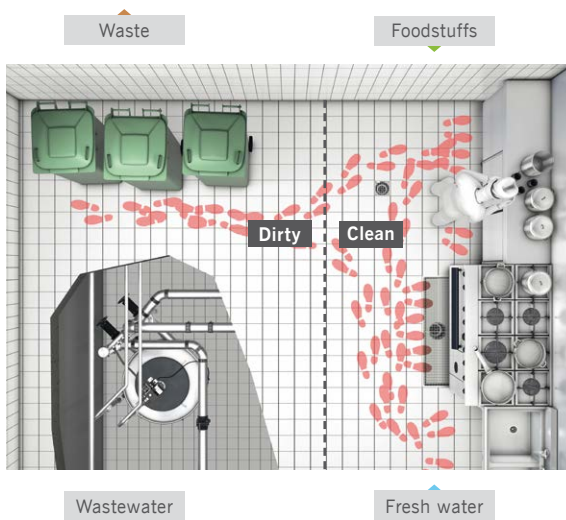

Traditional waste disposal system in commercial kitchen using bins and wet waste coolers

Cost control features of ACO Waste-Jets

The ACO Waste-Jet system improves kitchen organisation by shortening transport distances and enabling operators to reduce the amount of unproductive time used for cleaning and maintenance.

No cold storage area is required for waste – and there's no cost for aggregate maintenance.

Depending on the type of building, no second lift is required for waste disposal.

Health & Safety features of ACO Waste-Jets

The ACO Waste-Jet wet refuse collection system helps address health and safety issues related to organic waste disposal.

The fully automatic ACO Waste-Jet collection system ensures safe operation and maintenance.

Collection stations for wet waste disposal are integrated into kitchen design to reduce the risk of injury during the handling of organic waste.

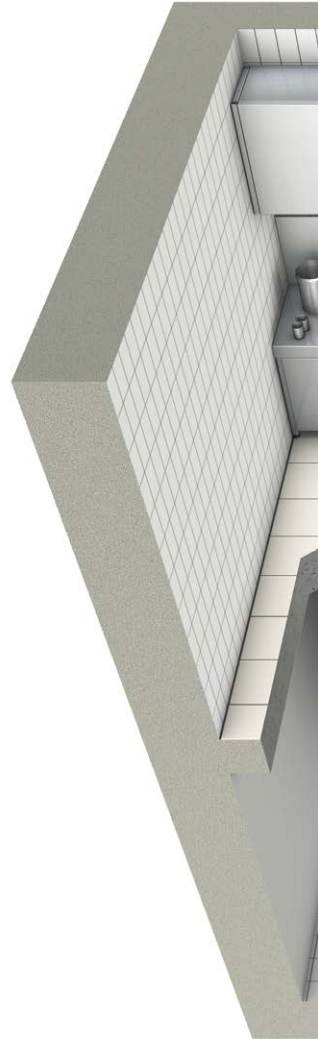

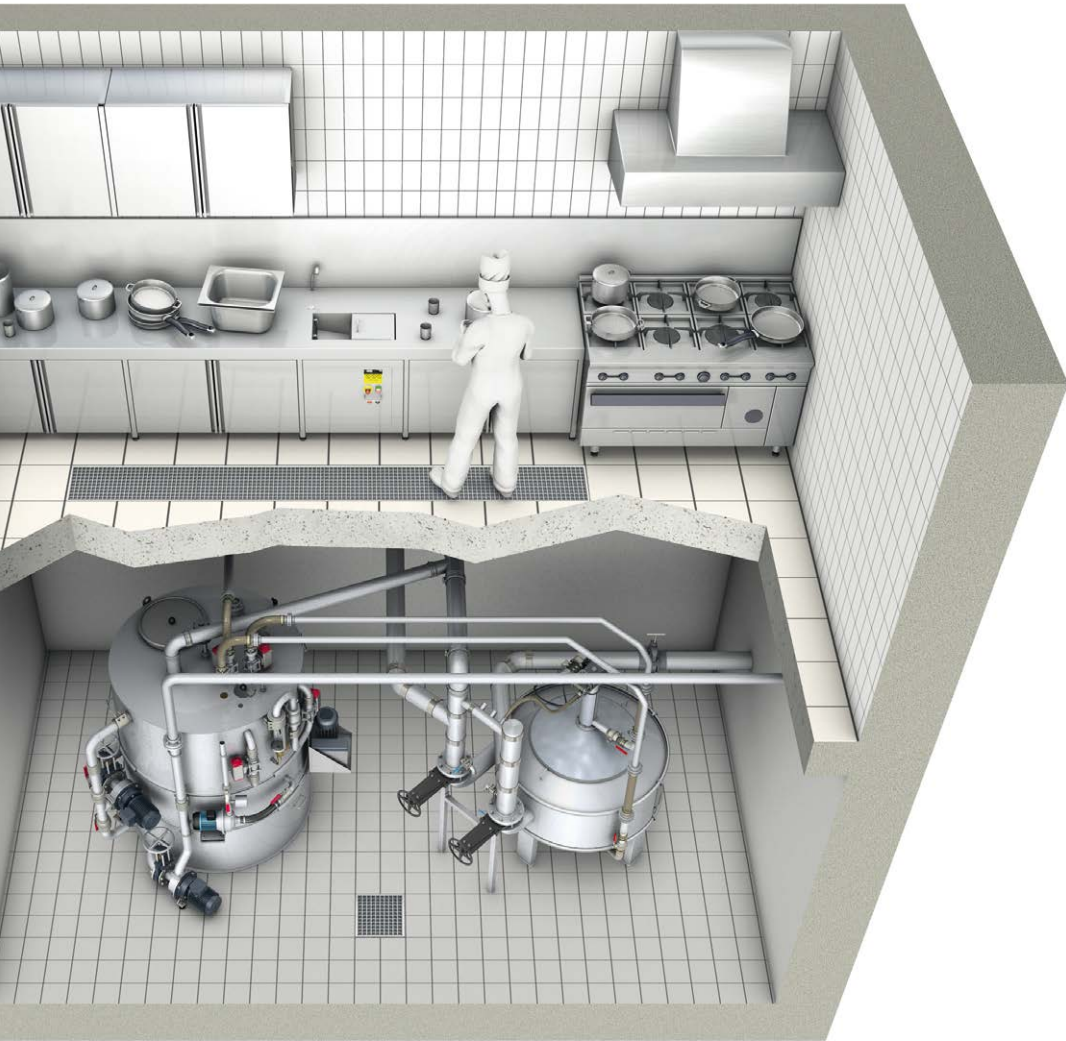

3.3.2. ACO waste disposal system

ACO wet refuse collection systems Tanks

The tanks for temporary storage in the ACO Waste-Jet system may be made from either stainless steel (grade 304) or plastic (polyethylene). Depending on the application and the selected material, the tanks come in different sizes and designs (high-pressure internal cleaning, disposal pump etc.). The fill-level monitoring is done using monitoring systems which are integrated in the tank. All containers are sealed to be odour-free and have inspection hatches for maintenance.



ACO wet refuse collection systems Collection Stations

In the ACO Waste-Jet system the tanks are filled using collection stations. These collection stations can, depending on requirements, be installed as free-standing units in the kitchen and next to dishwashers, or can be built in to work-surfaces. The collection stations for the Waste-Jet Comfort system transfer the wet waste to the tank using a vacuum system, while the Waste-Jet Classic system uses feed pumps. When the tank is full this is displayed visually at the collection station.



3.4. Related products

3.4.1. ACO lifting plant

Active backflow safety valve units are also differentiated according to the type of wastewater: either wastewater containing faeces or wastewater free of faeces. A large number of lifting plants, submersible pumps and pump stations are available for this purpose. Active backflow safety valves are used wherever there is no natural gradient towards the sewer, or when wastewater must be disposed of even during backflow affecting a system with a proper natural gradient.

Wastewater lifting plants are normally equipped with one pump. If wastewater drainage or wastewater inflow must be maintained without interruption during normal operations, EN 12056-4 specifies that a lifting plant with two pumps (twin system) each with the same output must be used. This always applies when draining deeper lying parts of multiplexes, offices, commercial buildings, hospitals, warehouses, or when wastewater is drained from separators.



The lifting plants/pump stations are operated so that the pumps are always operating alternately to ensure that they both undergo the same amount of wear. Twin units do therefore not mean that two pumps are normally operating at the same time. The wastewater lifting plants are compact systems for free-standing installation in cellars or shafts. EN 12056-4 stipulates that a working space of minimum 60 cm height and width must be present above and around the operating units to ensure that the necessary maintenance and control work can be carried out.

Another stipulation is that the room in which the lifting plant is installed is adequately ventilated and aerated, has lighting, and has a pump sump. Electrical components which must not be flooded should be installed in dry rooms not at risk of flooding. The following must be laid before installing a wastewater lifting plant:

- Inlet pipes
- Power supply
- Blank cable duct if necessary (when installed in floor recesses)

The wastewater is drained into the collecting tank of the wastewater lifting plant via the inlet pipes. The inlet pipes are usually DN 100 – DN 150 depending on the volume of wastewater.

All of the pipe connections must be unstressed. Pipes laid through walls and ceilings must be tight and sound proofed. (E.g. by using ACO APLEX pipe ducts).

3.4.2. ACO access cover

ACO access covers are a range of high quality access covers which, whilst providing quick and easy access to underground services, enable decorative floor finishes to be maintained with minimal interference.

ACO access covers are basically provided with a customer choice of surface. By filling the covers on-site with tiles, floor panels, carpet or other materials they blend harmoniously with the surrounding floor covering. Covers made from anti slip tread “checker” plate are also available for light industrial applications. ACO Access Covers are available up to load class N250, watertight and odourtight, certified according to EN 1253-4 or EN 124. There are three material variants available:

- Stainless steel, material grade 304 (1.4301)
- Galvanised steel
- Aluminium alloy

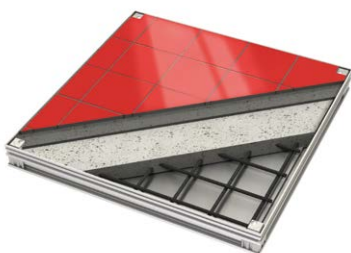

Access cover- standard

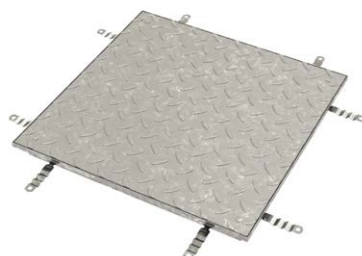

Access cover with opening assistance

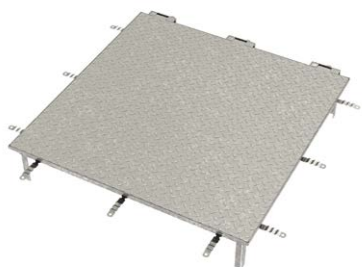

Please find relevant details and article numbers in ACO access covers catalogue or at www.aco-industrialdrainage.com

TECHNOLOGY AND CRAFTSMANSHIP
ARE AT HEART OF OUR BUSINESS

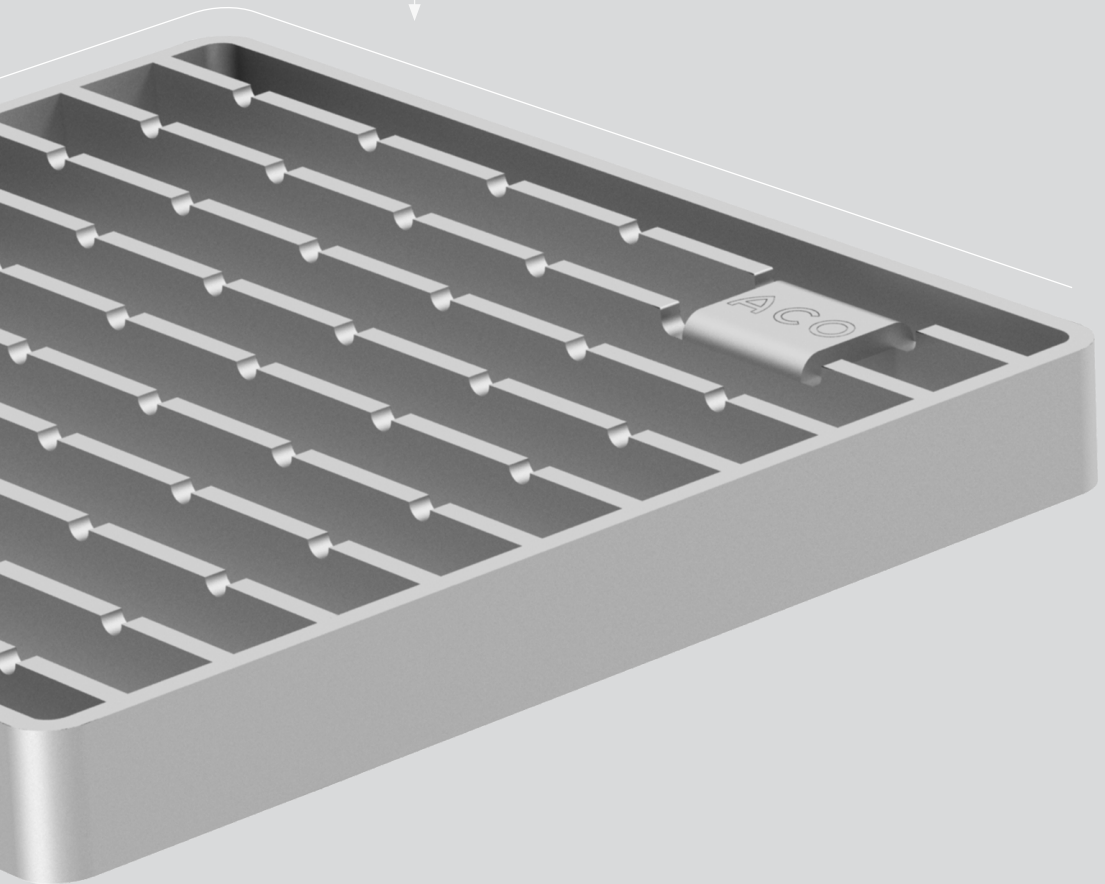

4. Material properties

4.1. Stainless steel

4.2. Surface treatment

4.1. Stainless steel

Stainless steel is the name given to a wide range of steels which have the characteristics of greatly enhanced corrosion resistance over conventional mild and low alloy steels. The enhanced corrosion resistance of stainless steel essentially comes from the addition of at least 11% chromium, however most stainless steels commonly used contain around 18% chromium. Other significant alloying elements include nickel and for superior corrosion resistant properties, molybdenum.

Stainless steel has the following unique advantages:

- High corrosion resistance
- Non-porous, easy to clean and disinfect
- Aesthetically pleasing
- Resistant to temperature extremes and thermal shock
- Coefficient of linear expansion similar to concrete
- 100% recyclable material

Austenitic Stainless Steels

ACO drainage is manufactured from austenitic stainless steel, grades 1.4301 or 1.4404 according to EN 10088 (304 or 316L according to AISI) and is ideal for applications including food processing, leisure, dairy, brewing, pharmaceutical, chemical and petrochemical industries.

4.2. Surface treatment

The process cutting, forming and welding stainless steel will introduce impurities into the surface of the material and unless the appropriate action is taken, the material will begin to corrode and ultimately fail in service. Therefore after fabrication, it is vital that stainless steel is treated with the correct surface treatment to ensure it is fully corrosion resistant. By applying pickle passivation as the primary surface treatment, the corrosion resistance of stainless steel can be fully restored to its original state, ensuring long and reliable life performance together with the required aesthetic appearance.

Finishes used by ACO include:

Pickle passivation (acid treatment)

All ACO drainage is pickle passivated by immersing products in a series of acid baths. This is a fundamental requirement for removing iron embedded particulates introduced in the fabrication process and also for restoring the chromium depleted regions generated by the welding process. ACO has one of the largest and most advanced pickle passivation installation in Europe which ensures the optimum corrosion resistance of our products.

Electropolishing (electrochemical process)

After pickle passivation, some products are then immersed in an electrolytic fluid in which the products become the anode of a direct current electrical circuit. This process is characterized by a selective attack of the surface of the components whereby upstanding roughness is preferentially dissolved and will yield a progressively smoother, brighter surface. All hygienic box channel grates are electro-polished as a standard.

Brushing (mechanical process)

ACO channels have brushed upper edge for aesthetical reasons.



SLIP RESISTANT
AND NO SHARP EDGES
FOR EMPLOYEE SAFETY



PREVENTS THE SPREAD
OF FIRE AND HIGH TEMPERATURES

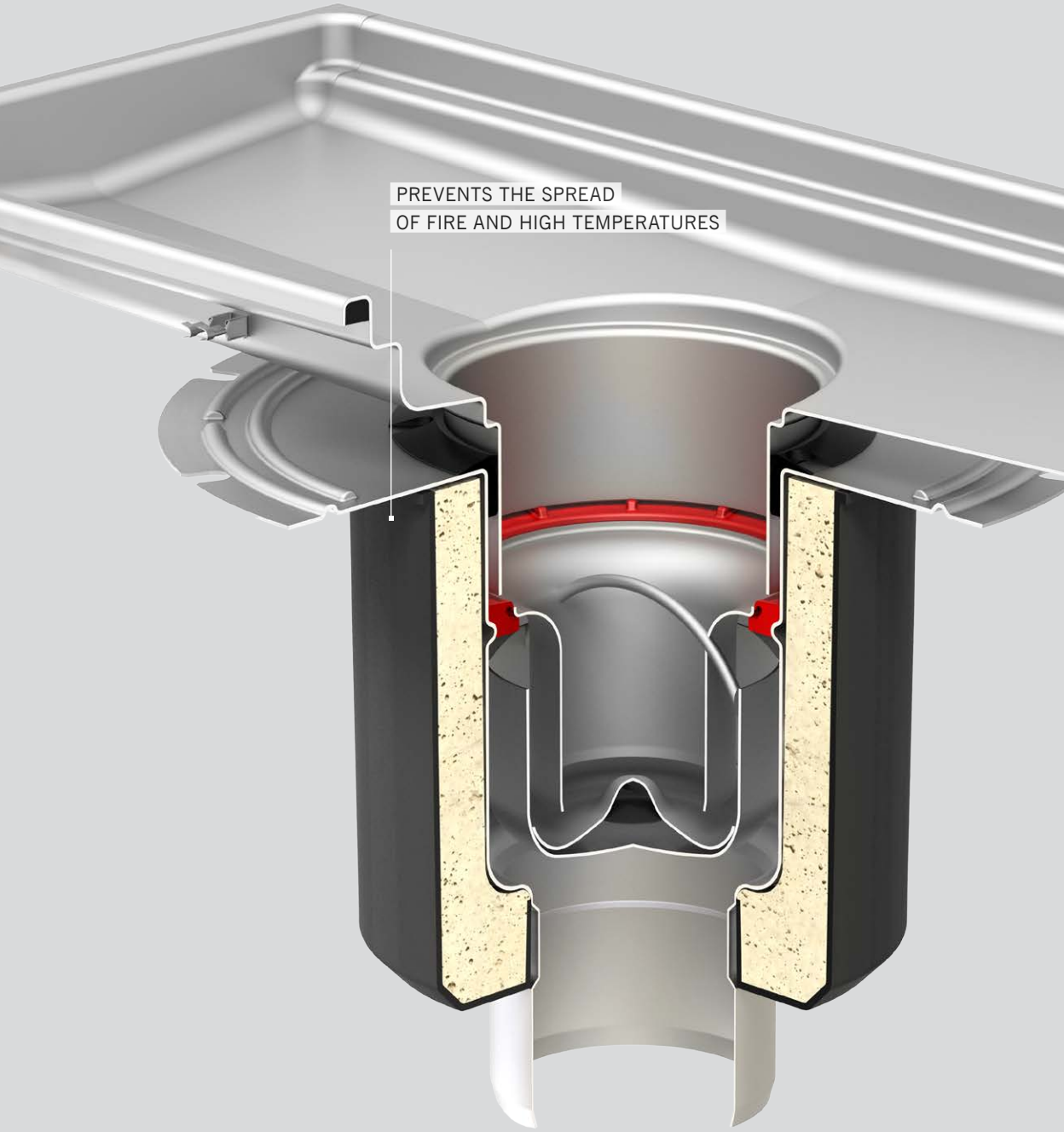

5. Fire protective solution

5.1. Introduction

5.2. Installation and function



5.1. Introduction

ACO has developed a solution which prevents the spreading of fire and high temperatures within different building's floors where ACO hygienic gully, ACO hygienic channel and ACO pipe are installed.

The solution has been tested according to EN 1366-2 Fire resistance tests for service installations and classified according to EN 13501 Fire classifications of construction products and building elements. For classification details please see chart below.

ACO fire protective kit can be used with telescopic vertical or fixed height vertical ACO hygienic gully and with ACO hygienic box channel, consisting of following items:

- External protection – Fit in
- Internal protection
- Fire protective foul air trap
- Fire protective foul air trap support

This solution has been designed and tested for use in either concrete or aerated concrete ceiling slabs with a minimum height of 150 mm.

ACO hygienic gully and ACO hygienic box channel installed with ACO fire protective kit can be connected to any kind of sewerage with ACO pipe regardless of its material, e.g. non combustible cast iron drain pipes SML, stainless steel ACO pipe (building material class A1) or plastic drain pipes (building material class B1/B2). All mentioned components of external and internal protection must be used to guarantee correct function of fire protection!

Tested at: PAVUS, a.s. protocol:

No. Pr-13-2.061

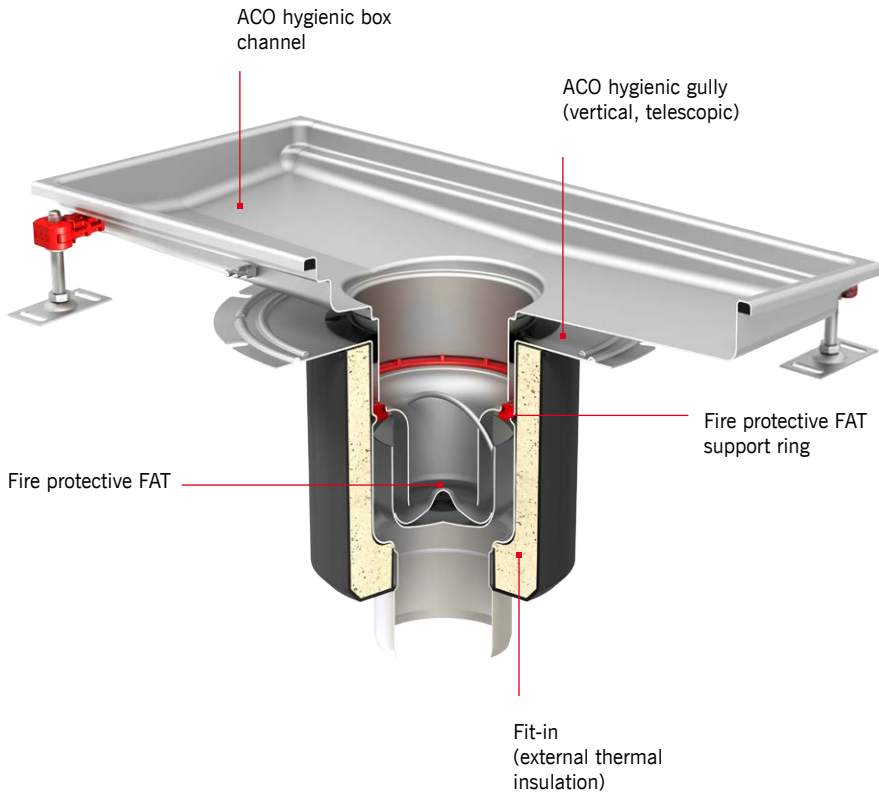

Gully type	Outlet diameter	Classification
ACO hygienic gully 142	75	EI 180
	110	EI 120
ACO hygienic gully 157	75	EI 180
	110	EI 120
ACO hygienic gully 218	110	EI 180
	160	EI 90

Classification according to EN 13 501, protocol: PK2-11-13-901-C-0

5.2. Installation and function

Before activation

- Installation scheme with assembled fire protective solution in ceiling construction.

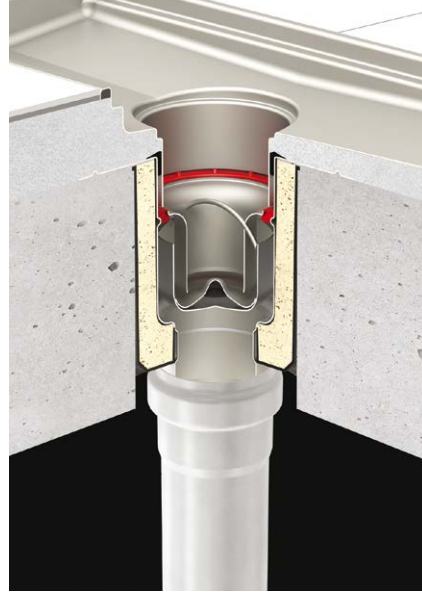

Fire activation

- Function of fire protective solution to prevent the spread of fire within storey structure by transmission (ACO gully).
- Time preventing the spread of fire is limited from 90 minutes to 180 minutes.

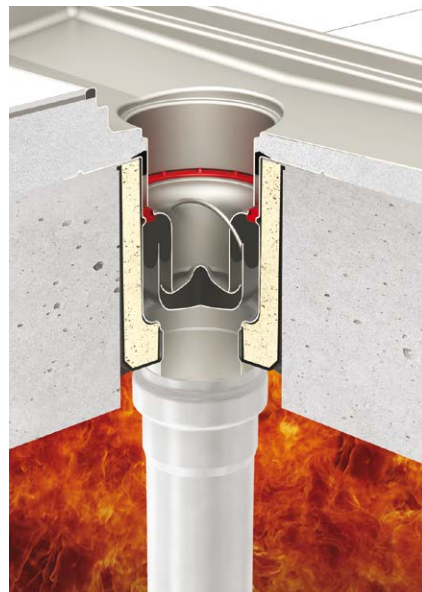

ACO pipe push-fit system is classified and certified as a non-combustible product (as it is manufactured in compliance to EN 1124, part 1 & part 2). This standard classifies the ACO pipe systems as class A1 fire resistant (highest rating).

ACO pipe systems are certified also by SITAC authority as fire resistant (cert. no. 0410-01). Special certificate of fire resistance for coated pipes (no. CSI PK-13-083) is available.

Fire certificates from marine authorities are available.

Non combustibility:

- Non combustible
- No additional fire collars needed at installation
- No toxic fumes emitted in case of fire
- EN 1124

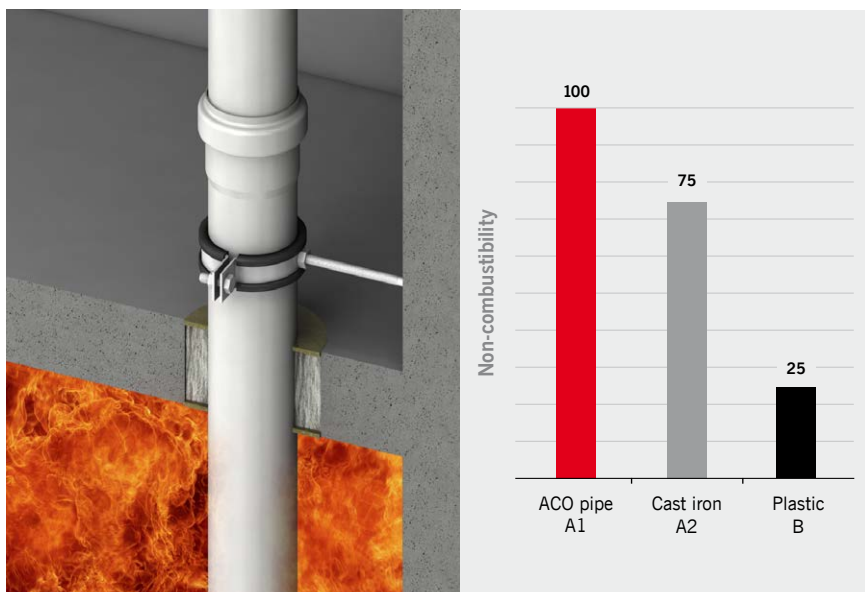



EASILY MAINTAINED - REDUCING
ASSOCIATED CLEANING COSTS



6. Cleaning and maintenance

6.1. Introduction

6.2. Principles of cleaning

6.3. Overview with recommended procedures for drainage

6.4. Manual cleaning of drainage

6.5. Chemical cleaning of drainage

6.1. Introduction

Drainage is a critical component affecting the hygienic performance of commercial food preparation business. Effective drainage helps to mitigate hazards from the external environment and is central to the safe and hygienic operation internally. Within the food service facility, surface liquids represent potential hazard of microbiological contamination. Liquids may be part of the cleaning process, or may originate from specific equipment discharge points, or be simply the result of an accidental spillage. Quite often the liquids contain other components – organic matter being predominant. Floor drainage components cater for these situations through three core functions - interception, conveyance of fluids, and ability to act as a barrier.

Effective cleaning of drainage in commercial food preparation business reduces risk of contamination and spoiling of food during preparation, processing, and storage. The main objective of cleaning is to remove soil to obtain clean surface and thereby reduce number of microorganisms. A further reduction of microorganism can be obtained by disinfection step.

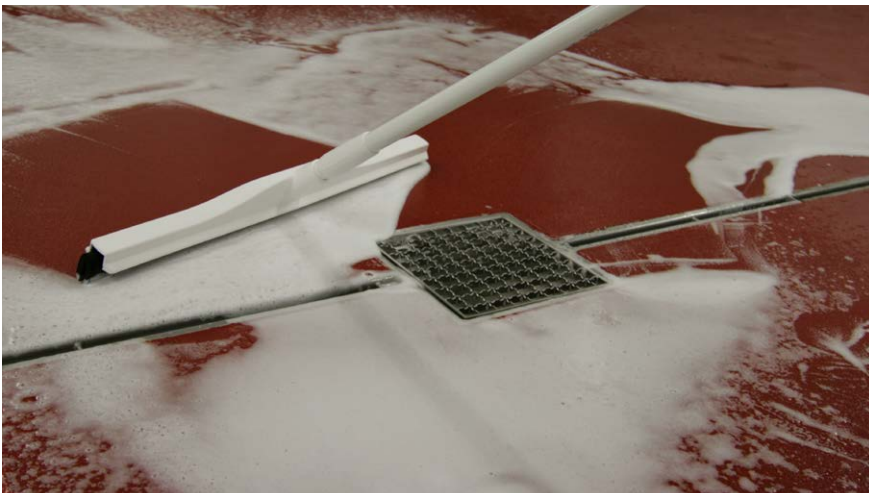

6.2. Principles of cleaning

The principles of cleaning involve combination of thermal, kinetic and chemical energy. The cleaning processes are always combination of these factors and time of these to work. The key point to highlight is that all equipment – including drainage – in food processing plant should have hygienic design, which is easy to clean and disinfect. Otherwise the cleaning process is time and energy consuming and not cost effective. All surfaces of ACO stainless steel drainage are hygienically designed – no sharp corners, edges, dead spaces and crevices. ACO drainage is easily accessible for cleaning and visual inspection.

The effectiveness of drainage cleaning depends on number of factors:

- Soil type and properties
- Material, design and surfaces
- Water quality
- Cleaning chemicals
- Cleaning procedure
- Cleaning parameters; like temperature, time, flow velocity and concentration of chemicals

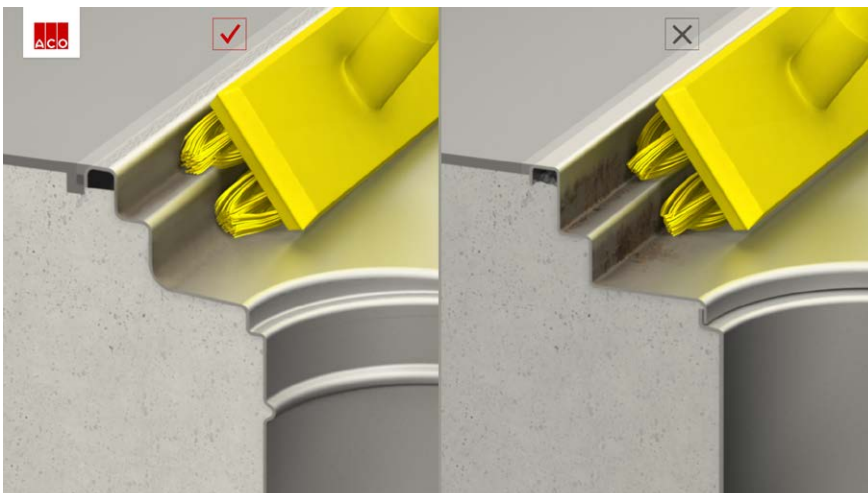

6.3. Overview with recommended procedures for drainage

These instructions are for guidance only. **Always follow manufacturer’s instructions.** All procedures have to be verified and adjusted to the application specifics.

Frequency	Procedure	Physical agents
Daily	Removal of organic deposits (fats, proteins, saccharides and polysaccharides)	<ul style="list-style-type: none"> ■ Steam ■ Medium pressure water to max 25 bar ■ Mechanical / kinetic energy (brushes, CIP medium velocity)
Weekly	Removal of inorganic deposits that could promote very resistant biofilms	Mechanical abrasive methods – polishing
Note	Removal of rinse water residues	Removal of excess water with a squeegee

Frequency	Chemical agents	Examples of chemical cleaning agents suitable for ACO stainless steel drainage
Daily	<ul style="list-style-type: none"> ■ Caustics (sodium hydroxide, potassium hydroxide) ■ Detergents / surfactants 	Standard chemical agents used for floor cleaning should be sufficient (should be validated) Oxofeam, Endorochlor (Diversey)
Weekly	<ul style="list-style-type: none"> ■ Nitric acid for stainless steel passivation where chlorine attack could be expected ■ Inorganic acids (phosphoric acid) ■ Weak organic acids 	<ul style="list-style-type: none"> ■ Acifoam (Diversey) ■ Acigel (Diversey) ■ Super Dilac (Diversey)
Note	Alcohols (isopropylalcohol, ethanol)	Chlorine tablets (Suma Tab D4 by Diversey) are often added to the water in foul trap in microbial sensitive production area's

Any cleaning procedures, including those recommended by equipment suppliers, must be properly validated at the equipment, where it will be applied and on the soil that could be expected even after certain time of usage.

Always follow manufacturer’s instructions to avoid damage to the equipment.

6.4. Manual cleaning of drainage

- 

1 Remove all present grocery, raw materials, wrapping materials and tools.
- 

2 Cover all equipment that could be contaminated.
- 

3 Remove excess dirt from floor and gratings, and place into designated container.
- 

4 Remove gratings.
- 

5 Remove and empty silt basket and foul air trap.
- 

6 Place collected waste and dirt into designated container. Rinse grating, silt basket and foul air trap with clean water. Then place foul air trap into its original position.
- 

7 Wash all surfaces with designated detergent and designated hand brush.
- 

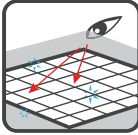

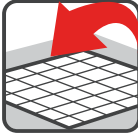







8 Rinse all surfaces with clean water.
- 

9 Visually check surface cleanliness - repeat cleaning process if necessary.
- 

10 Place silt basket and grating to its original position.
- 

11 Rinse the entire equipment with clean water.

6.5. Chemical cleaning of drainage

- 1**  Remove all present grocery, raw materials, wrapping materials and tools.
- 2**  Cover all equipment that could be contaminated.
- 3**  Remove excess dirt from floor and gratings; and place into designated container.
- 4**  Remove gratings.
- 5**  Remove and empty silt basket and foul air trap.
- 6**  Place collected waste and dirt into designated container. Rinse grating, silt basket and foul air trap with clean water. Then place foul air trap into its original position.
- 7**  Apply foam to all surfaces.
- 8**  Leave foam for 15 minutes.
- 9**  Rinse off foam with clean water.
- 10**  Visually check surface cleanliness - repeat cleaning process if necessary.
- 11**  Place silt basket and grating to its original position.
- 12**  Rinse the entire equipment with clean water.



7. Kitchen layouts



Preparation area

Disposal area

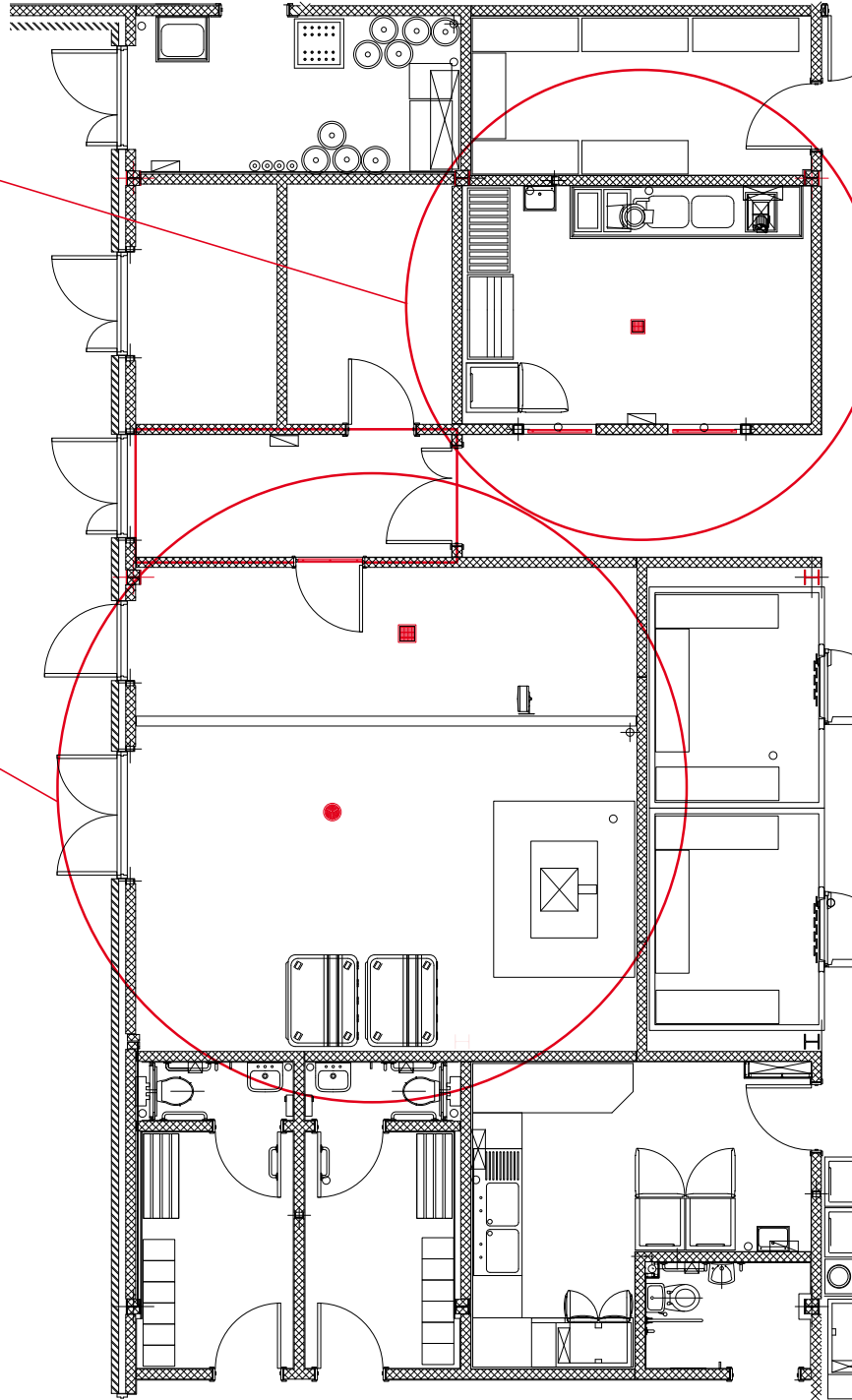

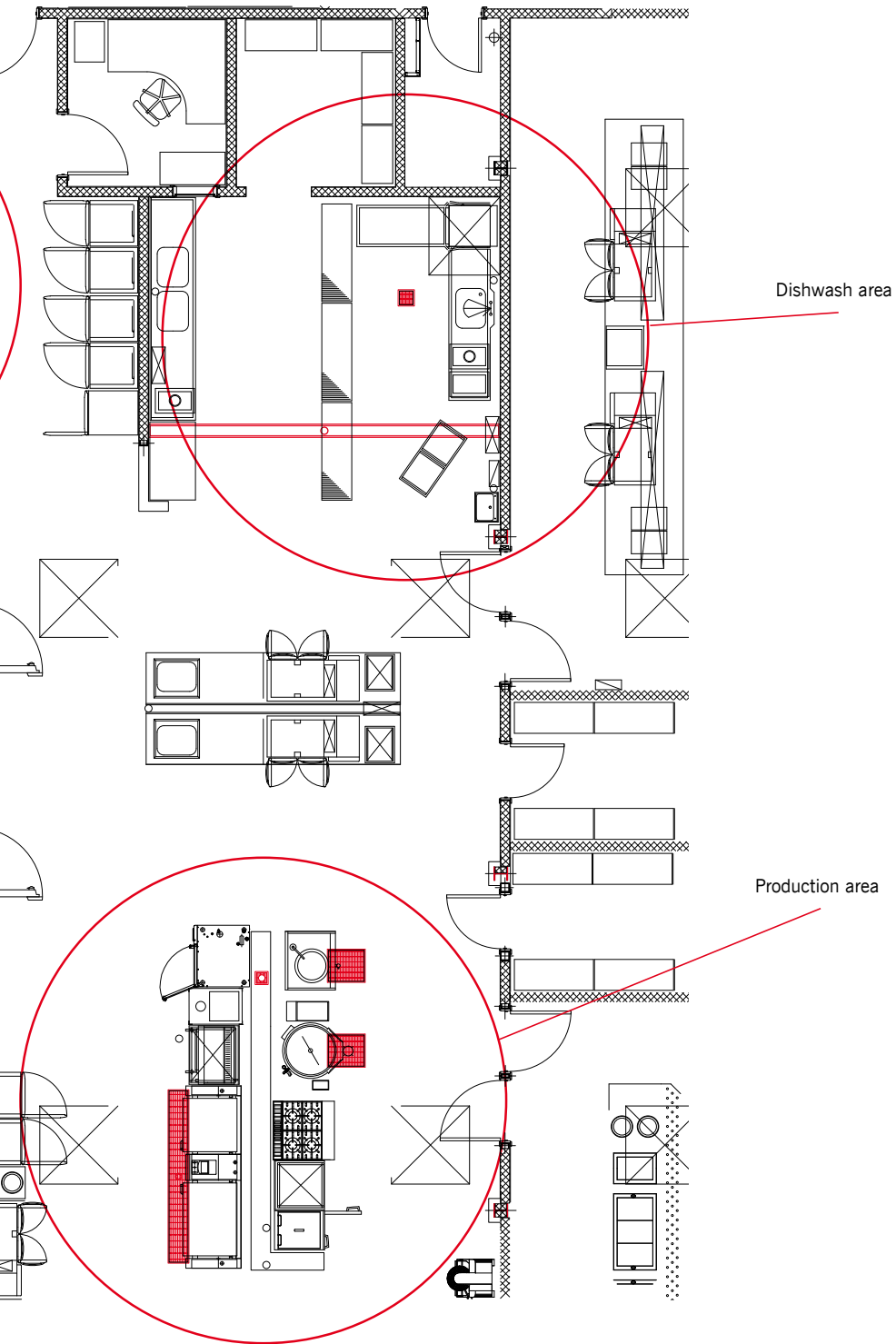

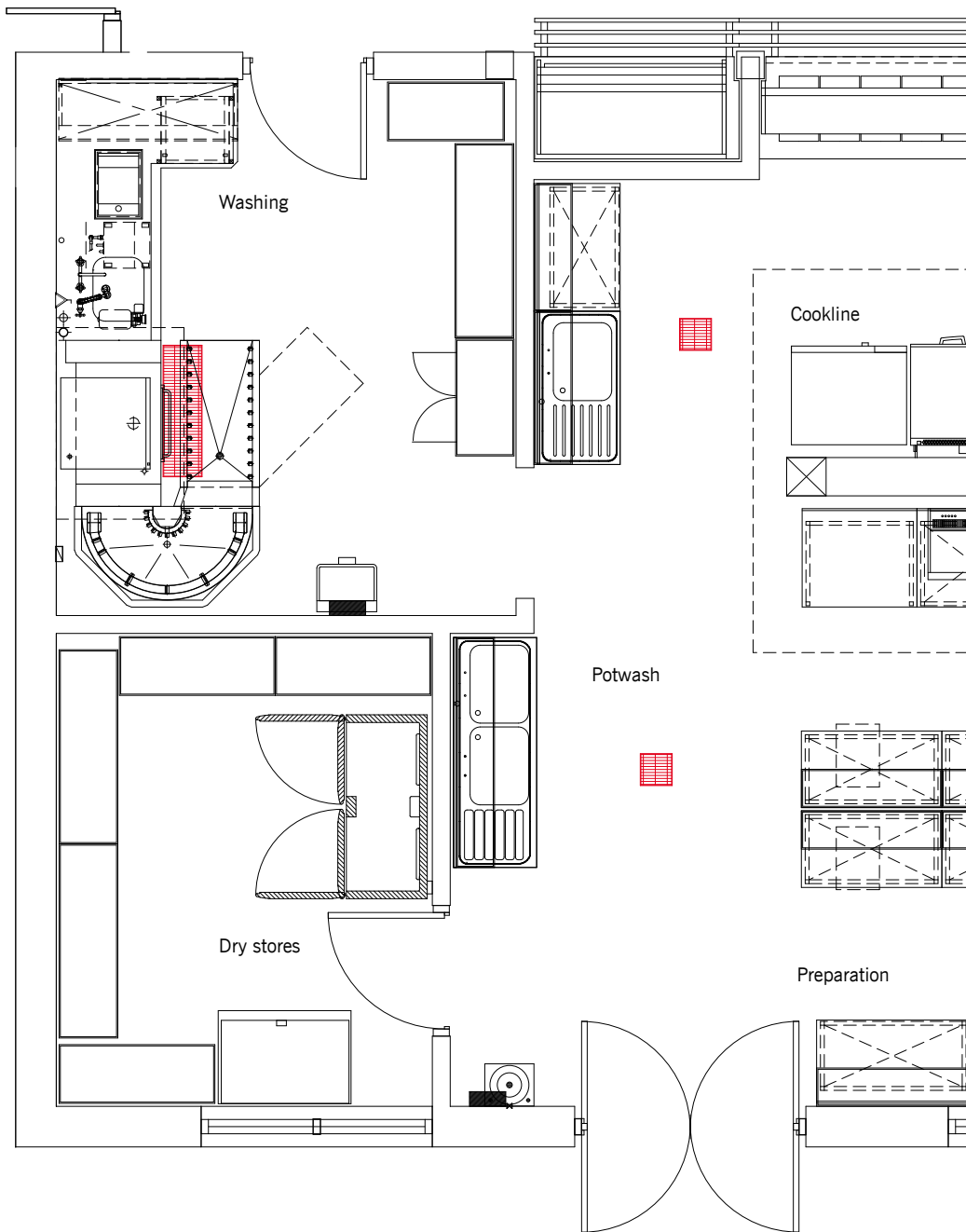

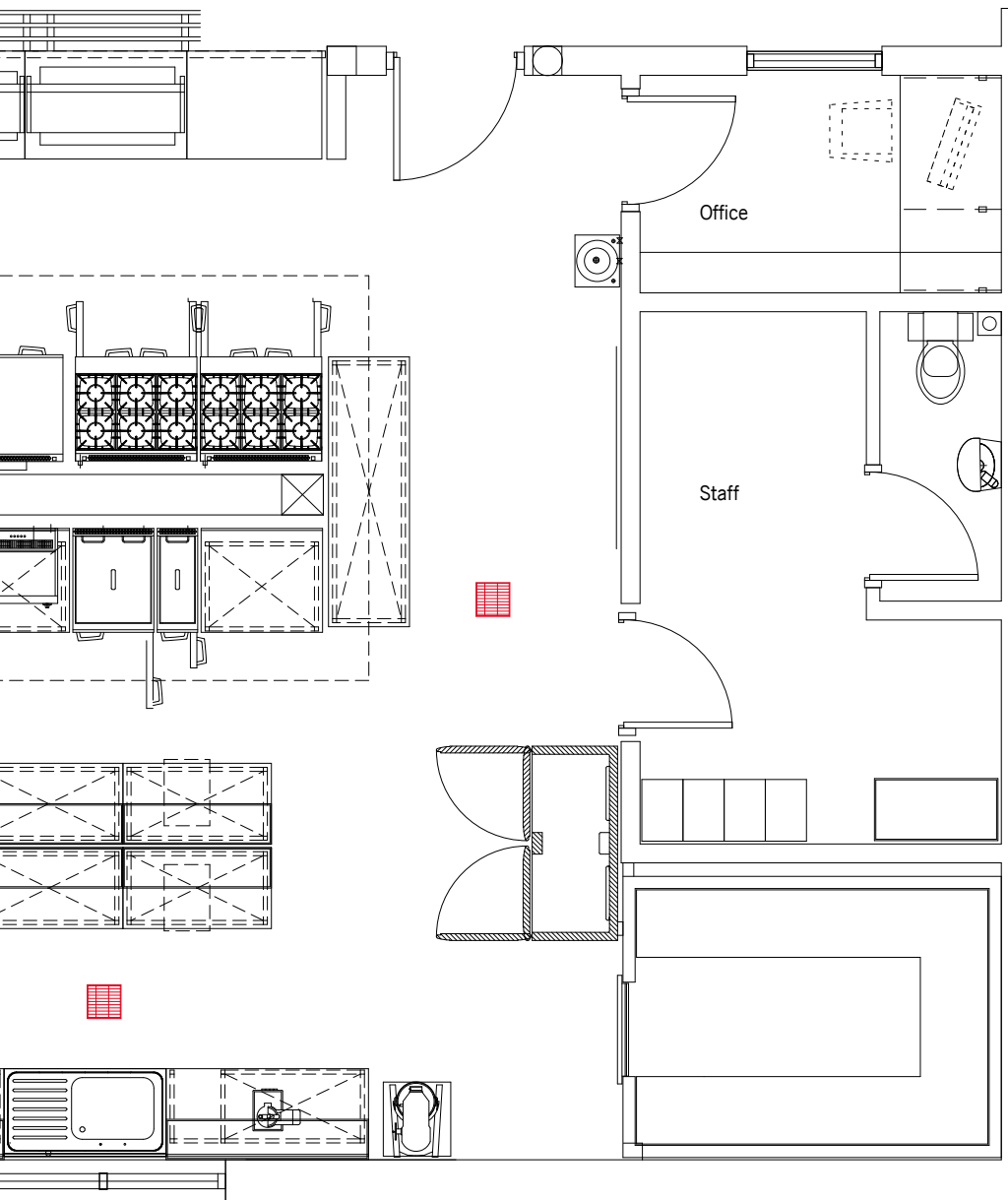

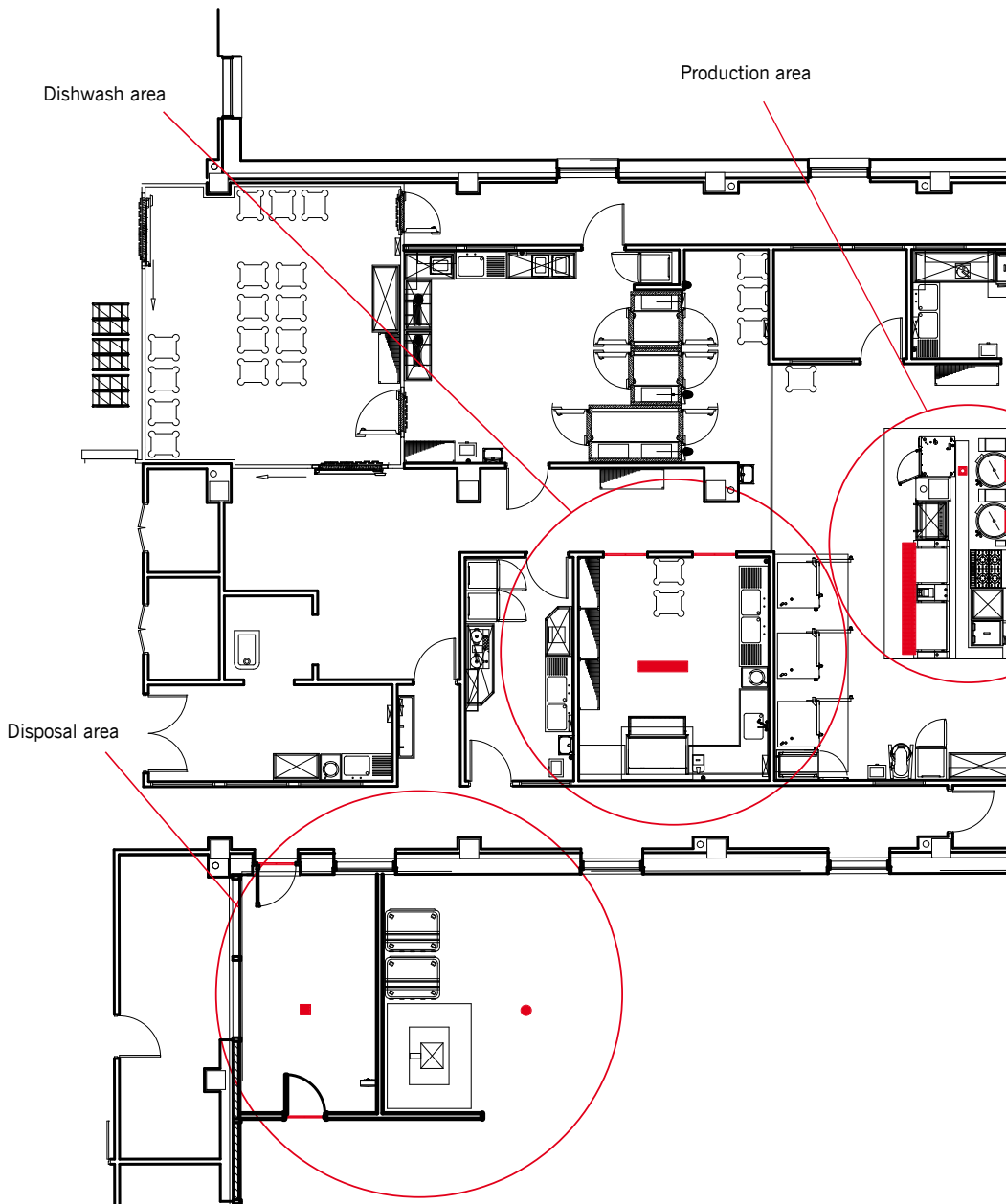

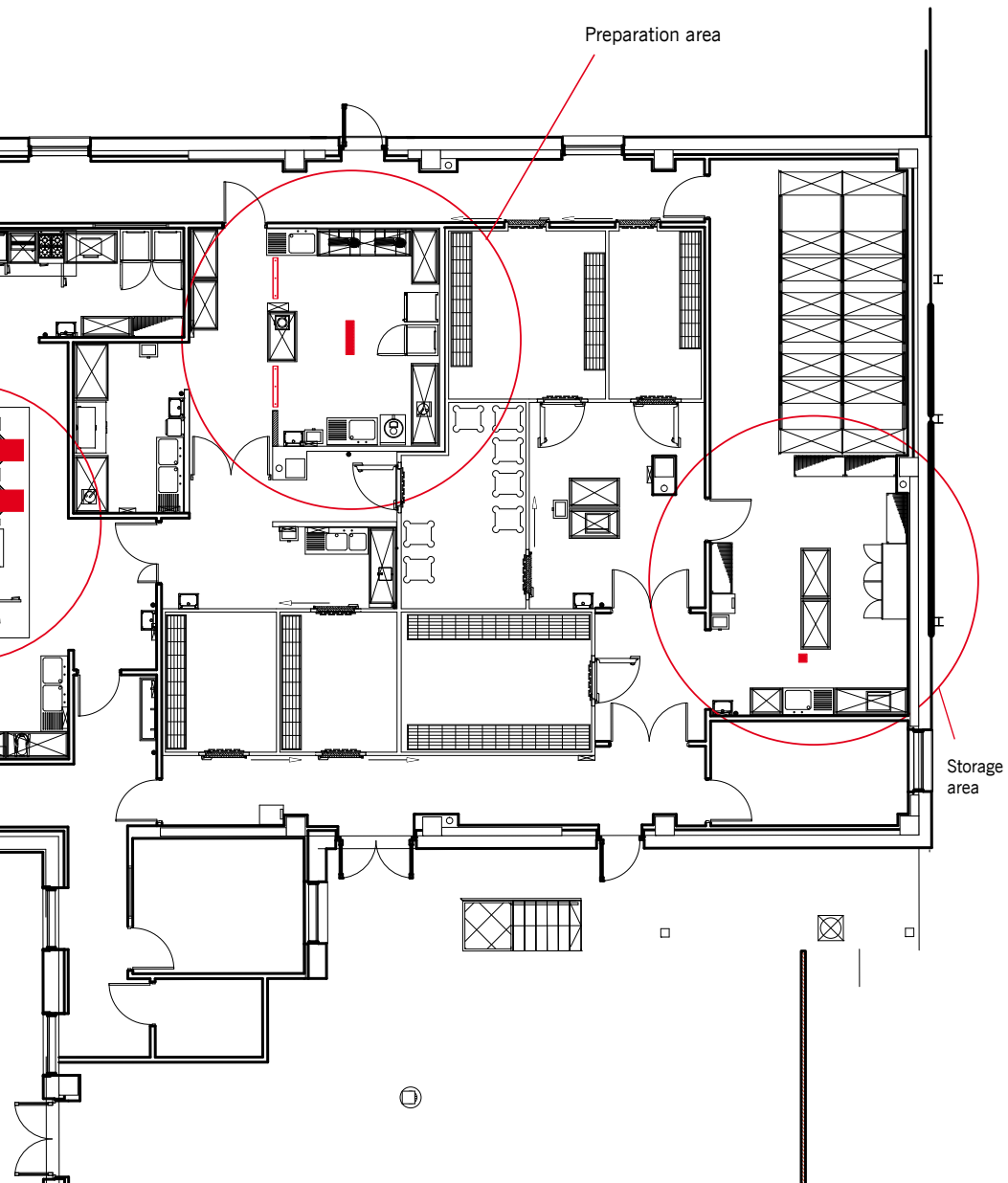

Preparation area

Storage area

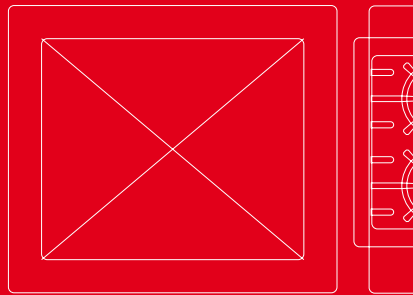
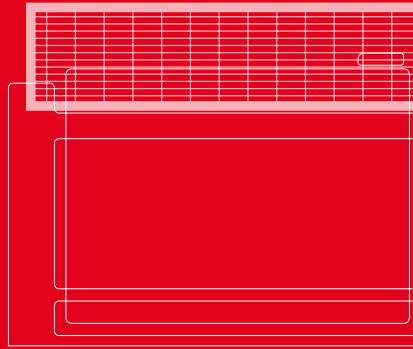

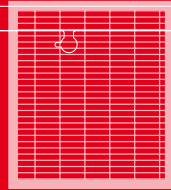
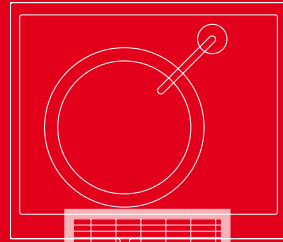
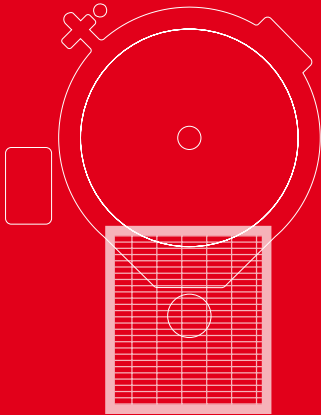
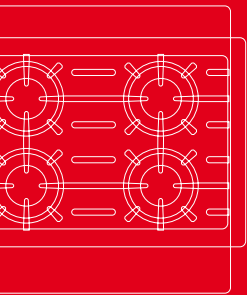
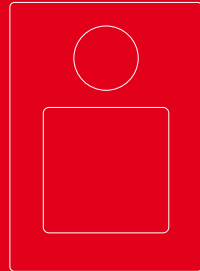
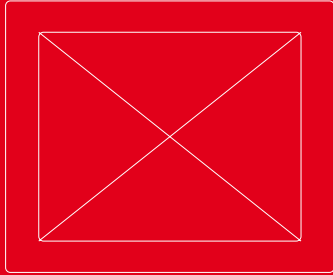
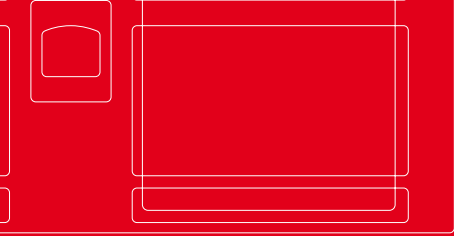
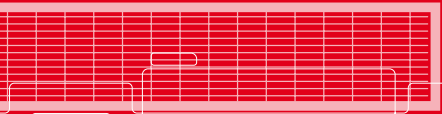

Do not **underestimate** your drainage

Visit www.hygienefirst.com

